





Isotop® DZE

Pressure-tension element with high-performance damper

- Natural frequency from 7 Hz
- Resistant to compression and tension
- Reduces strong amplitudes
- Designed for horizontal forces up to 5 kN per element (DZE-1)
- Can be used from an installation height of 49 mm (DZE Mini)
- Sylodyn® and Sylodamp® inside
- Load capacity of more than 4 t per element (DZE-BL)
- Stainless steel housing and continuous stainless steel piping for highest levels of corrosion protection
- Rapid installation thanks to pre-assembled elements

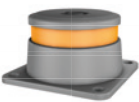
		Maximum load		Natural frequency at maximum load	Packaging unit	Order number
		in kg	in N			
DZE Mini 	Isotop® DZE Mini NB SP1	9	88	10.3 Hz	10 pcs.	43799
	Isotop® DZE Mini NC SP1	17	167	10.7 Hz	10 pcs.	43800
	Isotop® DZE Mini ND SP3	38	373	10.1 Hz	10 pcs.	43801
	Isotop® DZE Mini NE SP3	75	735	10.3 Hz	10 pcs.	43802
	Isotop® DZE Mini NF SP3	110	1,079	10.1 Hz	10 pcs.	43803
	Isotop® DZE Mini HRB 3 SP3	230	2,256	11.6 Hz	10 pcs.	43804

DZE 	Isotop® DZE-1-NB-SP	Single layer	28	275	10.3 Hz	10 pcs.	39614
	Isotop® DZE-1-NC-SP	Single layer	55	540	10.1 Hz	10 pcs.	39615
	Isotop® DZE-1-ND-SP	Single layer	122	1,196	9.9 Hz	10 pcs.	39616
	Isotop® DZE-1-NE-SP	Single layer	238	2,305	10.1 Hz	10 pcs.	39617
	Isotop® DZE-1-HLL-SP5	Single layer	800	7,848	12.0 Hz	10 pcs.	39618
	Isotop® DZE-1-HLH-SP5	Single layer	1,030	10,104	11.5 Hz	10 pcs.	39619
	Isotop® DZE-2-NB-SP	Double layer	25	245	7.2 Hz	10 pcs.	39442
	Isotop® DZE-2-NC-SP	Double layer	48	471	7.6 Hz	10 pcs.	39620
	Isotop® DZE-2-ND-SP	Double layer	107	1,050	7.0 Hz	10 pcs.	39621
	Isotop® DZE-2-NE-SP	Double layer	205	2,011	7.1 Hz	10 pcs.	39622
	Isotop® DZE-2-HLL-SP5	Double layer	630	6,180	8.1 Hz	10 pcs.	39623
	Isotop® DZE-2-HLH-SP5	Double layer	820	8,044	7.7 Hz	10 pcs.	39624

DZE-BL 	Isotop® DZE-1-BL2-HLH-SP5	Single layer	2,065	20,258	11.5 Hz	10 pcs.	42595
	Isotop® DZE-1-BL4-HLH-SP5	Single layer	4,135	40,564	11.5 Hz	10 pcs.	42597
	Isotop® DZE-2-BL2-HLH-SP5	Double layer	1,635	16,039	7.7 Hz	10 pcs.	42598
	Isotop® DZE-2-BL4-HLH-SP5	Double layer	3,270	32,079	7.7 Hz	10 pcs.	42599

DZE-BL: Not held in stock. Delivery time on request (approx. 15 working days from the factory)

Maximum force in horizontal direction

Type	Maximum force
Isotop® DZE-1	5 kN
Isotop® DZE-2	2 kN
Isotop® DZE Mini	2 kN
Isotop® DZE-1-BL2	10 kN
Isotop® DZE-1-BL4	20 kN
Isotop® DZE-2-BL2	4 kN
Isotop® DZE-2-BL4	8 kN

Isotop® DZE Railway is also available specially for rolling stock!





Recoiler with Isotop® DZE to counter very high wind loads



Pump with Isotop® DZE to compensate for high dynamic operating forces

Isotop® DZE-Mini (unladen)

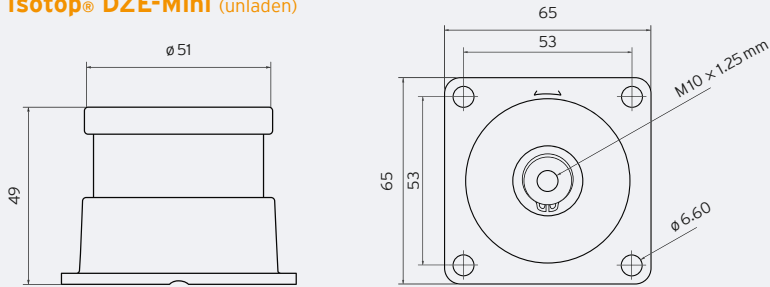

Please note: a 1.25 mm fine-pitch thread is required to make the connection

Isotop® DZE-2 (unladen)

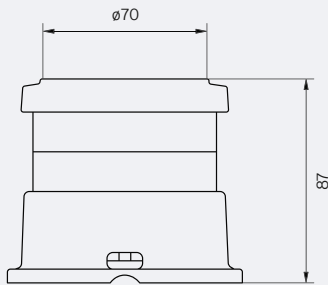

Isotop® DZE-1 (unladen)

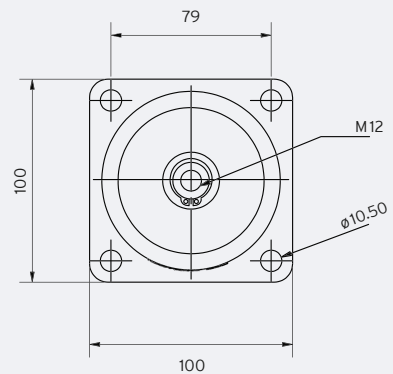
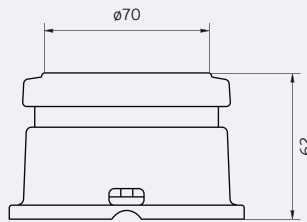

Isotop® DZE-x-BL2 (unladen)

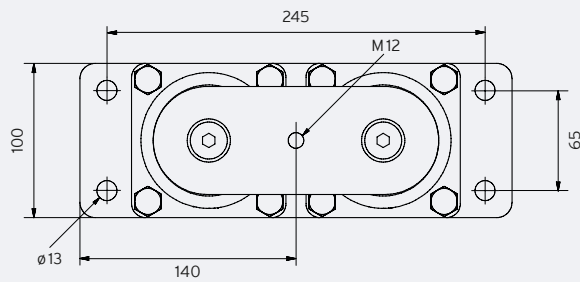
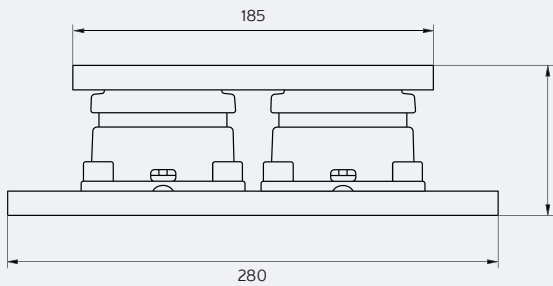

Isotop® DZE-x-BL4 (unladen)

