

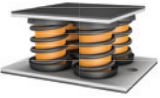

Isotop DSD-BL

DSD steel spring block element with high-performance damper

- Natural frequency from 4.3 Hz
- High load capacity of up to 5,850 kg per element
- Sylodamp[®] inside - ideal for machines with several start-stop cycles
- CDC coating of springs and powder coating of pressure plates for outstanding corrosion protection
- 6 mm top plate and base plate fitted with 4 mm Sylomer[®] anti-slip plate
- Secure connection between the plate and the spring thanks to special adhesive
- Top plate with M12 thread
- Simple load control thanks to open design

DSD-BL		Maximum load		Natural frequency at maximum load	Packaging unit	Order number
		in kg	in N			
	Isotop DSD-BL2-62/70	400	3,924	4.3 Hz	4 pcs.	47257
	Isotop DSD-BL2-72/80	730	7,161	5.2 Hz	4 pcs.	47258
	Isotop DSD-BL2-82/90	940	9,221	4.7 Hz	4 pcs.	47264
	Isotop DSD-BL2-81/91	1,120	10,987	4.7 Hz	4 pcs.	47262
	Isotop DSD-BL2-80/92	1,300	12,753	4.6 Hz	4 pcs.	47260
	Isotop DSD-BL4-72/82	1,560	15,304	4.8 Hz	4 pcs.	47271
	Isotop DSD-BL4-84/90	1,880	18,443	4.7 Hz	4 pcs.	47275
	Isotop DSD-BL4-82/92	2,240	21,974	4.7 Hz	4 pcs.	47274
	Isotop DSD-BL4-80/94	2,600	25,506	4.6 Hz	4 pcs.	47272
	Isotop DSD-BL6-86/90	2,820	27,664	4.7 Hz	10 pcs.	47281
	Isotop DSD-BL6-80/96	3,900	38,259	4.6 Hz	10 pcs.	47280
	Isotop DSD-BL9-80/99	5,850	57,389	4.6 Hz	10 pcs.	47283

Not held in stock. Delivery time on request (approx. 15 working days from the factory).

Isotop DSD-BL 2 (unloaded)

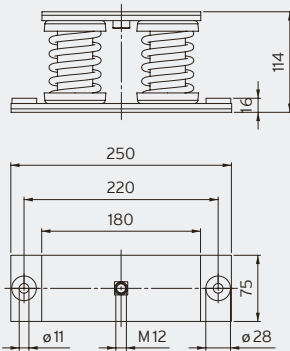

Isotop DSD-BL 4 (unloaded)

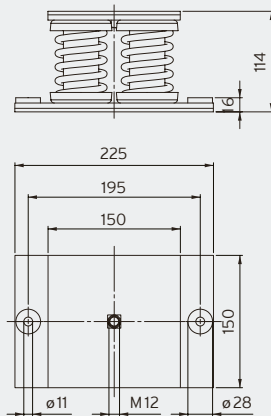

Isotop DSD-BL 6 (unloaded)

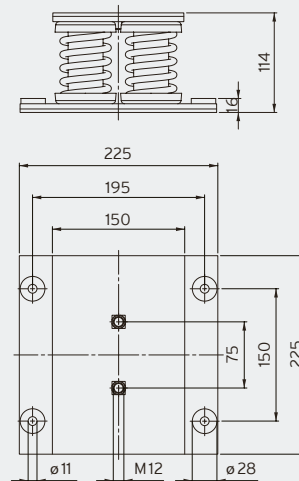

Isotop DSD-BL 9 (unloaded)

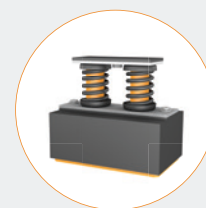
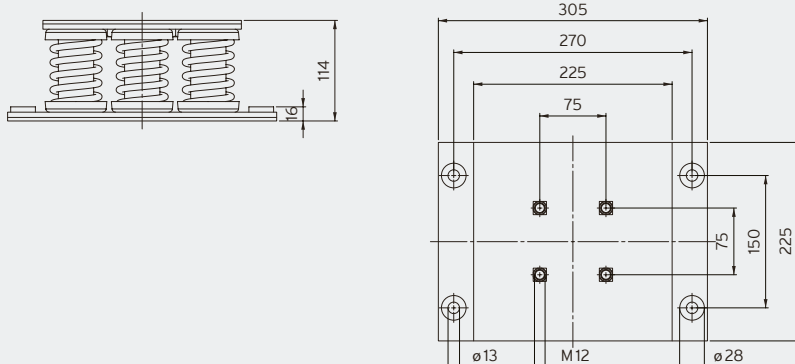

Isotop DSD-BL2 and DSD-BL4 optionally available with spacer base

Details on page 28



Customised block elements available on request



On-roof installation of an HVAC system with relatively high wind loads



Large combined heat and power plant with several start-stop cycles

Isotop DSD-BL 2

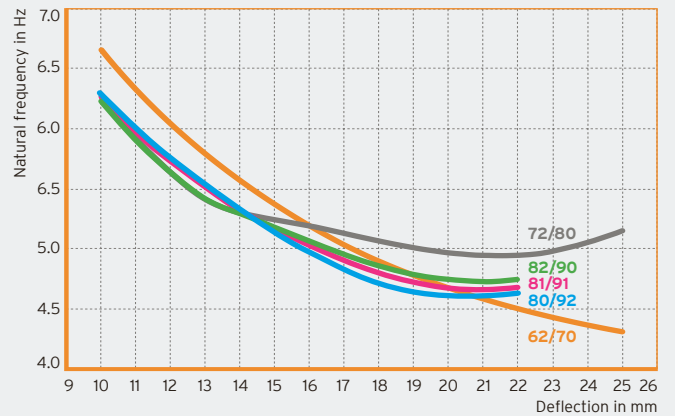
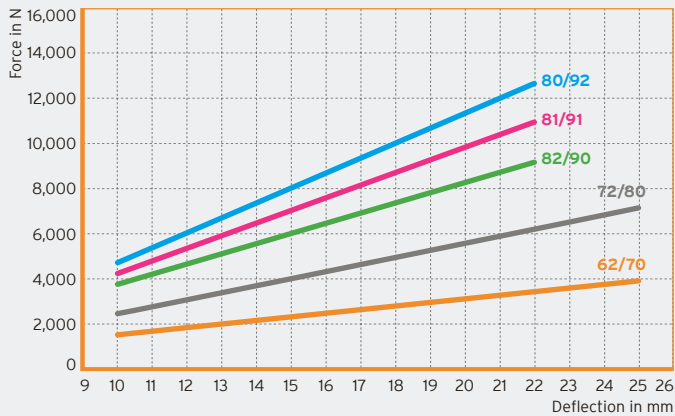

Isotop DSD-BL 4

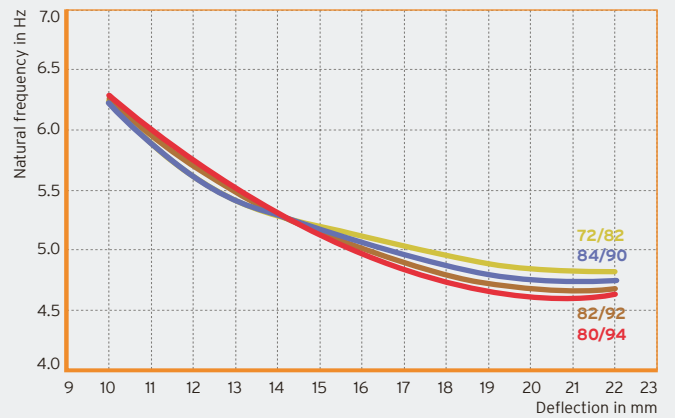
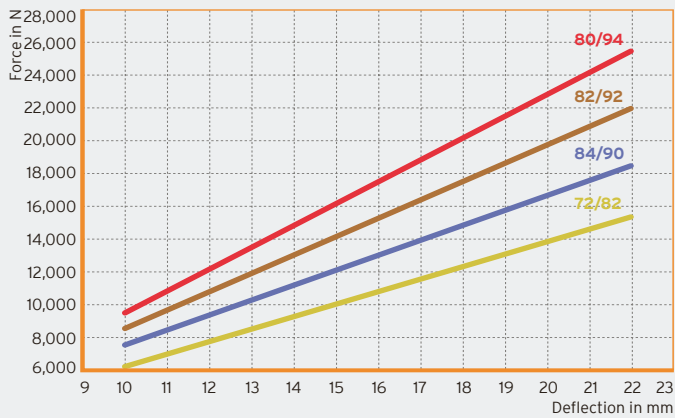

Isotop DSD-BL 6 and DSD-BL 9

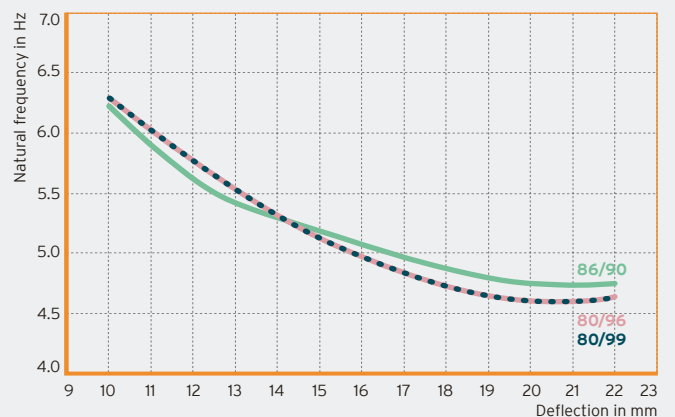
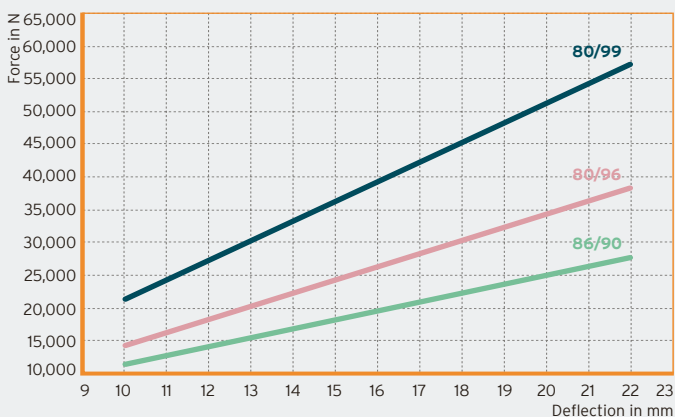

DB Isotop: © Copyright by Getzner Werkstoffe GmbH | 02-2022 | All information and data is based on our current knowledge. It can be used in calculations and for reference purposes, but is subject to product-specific and application-specific manufacturing tolerances and does not represent warranted properties. Material properties and their tolerances vary depending on the type of application and load and are available from Getzner on request. Subject to change without notice. For further general information, see VDI directive 2062 and glossary. Further characteristic values available on request.