

# ISOTOP® STEEL SPRINGS WITH DAMPER CORES

## DATASHEET



Quickly find the right Isotop® machine bearing for your application with the EquipCalc selection program from Getzner.



Register online now  
[apps.getzner.com](https://apps.getzner.com)

## PRODUCT BENEFITS

- Effective absorption of mechanical energy with simultaneous reduction in vibrations
- Conversion of kinetic energy leads to improved shock absorption
- The durable properties of the damper core ensure consistent performance over long periods of time

All information and data are based on our current knowledge. It can be used in calculations and for reference purposes, but is subject to product-specific and application-specific manufacturing tolerances and does not represent warranted properties. Material properties and their tolerances vary depending on the type of application and load and are available from Getzner on request. Subject to change without notice.

For further general information, see VDI Directive 2062 and glossary.  
Further characteristic values available on request.

**getzner**

# ISOTOP® DSD



## Isotop® type overview

Static application range

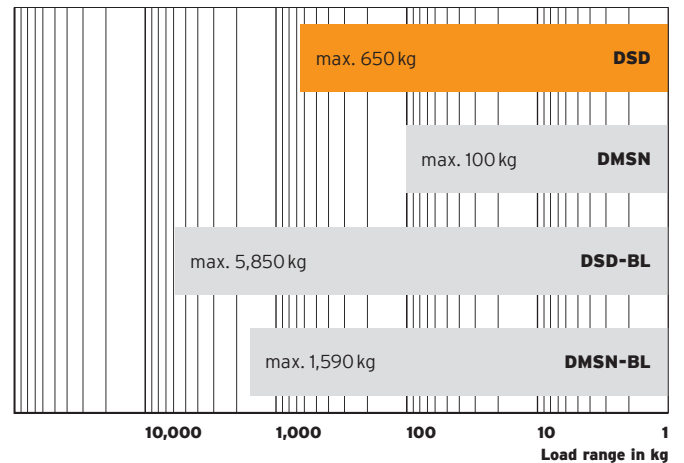

## Description

<b>Category</b>	Steel spring with damper core Design conforms to DIN EN 13906-1
<b>Material</b>	Metal caps made of steel Spring steel 75 mm Sylodamp® damper core
<b>Dimensions</b>	H 94 mm / D 70 mm

## Product characteristics

<b>Natural frequency from</b>	4.2 Hz
<b>Load range</b>	0-650 kg / 6377 N
<b>Overall height, unloaded</b>	94 mm
<b>Connection thread</b>	M10 internal thread
<b>Coating</b>	Cathodic dip-painted
<b>Permissible temperature range</b>	-30°C to +70°C
<b>Suitable accessories</b>	Isotop® FP/K 1-9 KTL Isotop® FP 1-9 KTL Isotop® NV 1-9



[getzner.com/  
spring-mounts-dampercore](https://www.getzner.com/spring-mounts-dampercore)

**Isotop® SD**  
(unloaded)

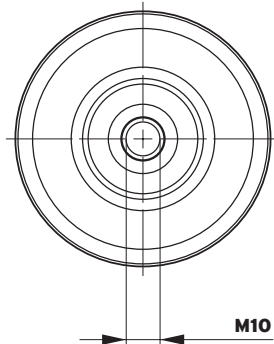
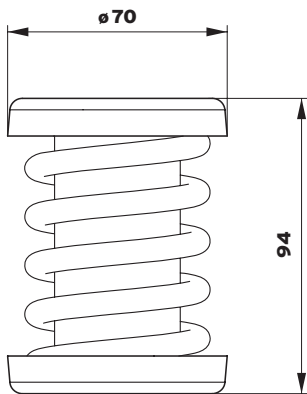

**Isotop® NV 1-9**

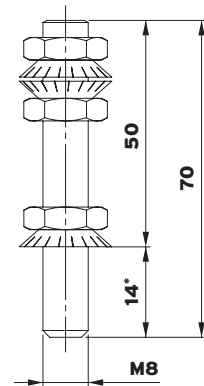

\*Thread reach SD/DSD

**Isotop® FP/K**

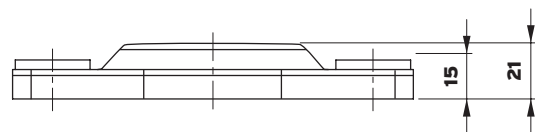
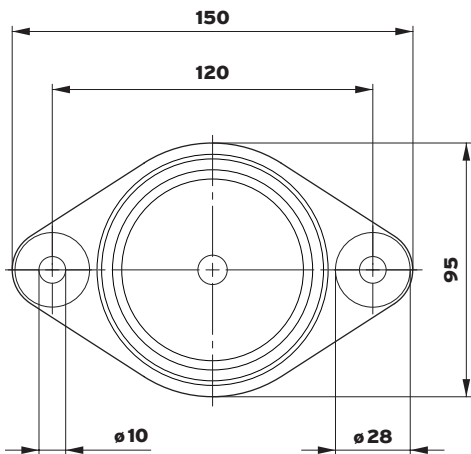

**Isotop® FP**

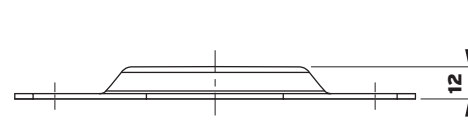
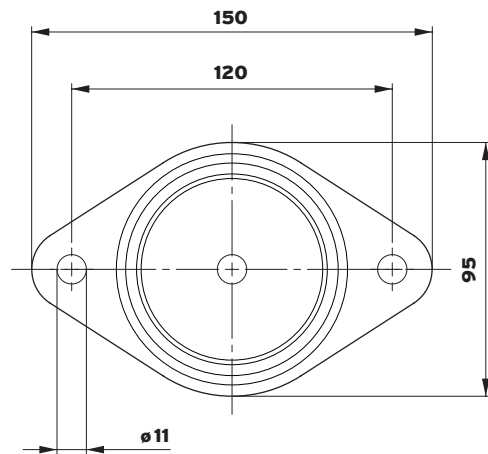

### Isotop® DSD 1

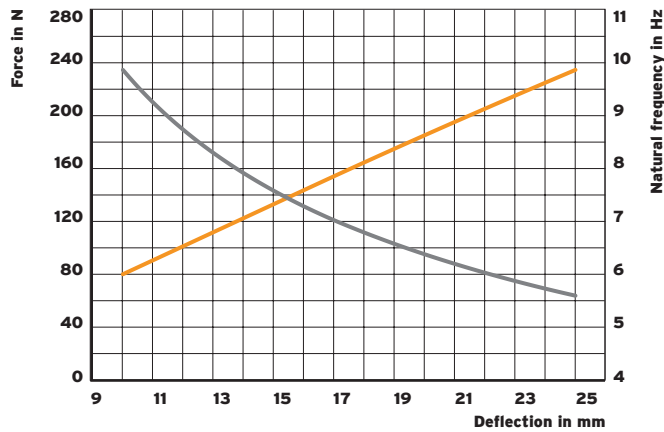

### Isotop® DSD 2

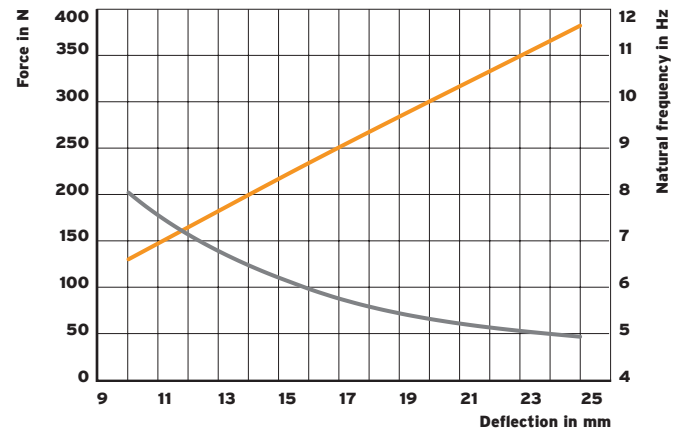

### Isotop® DSD 3

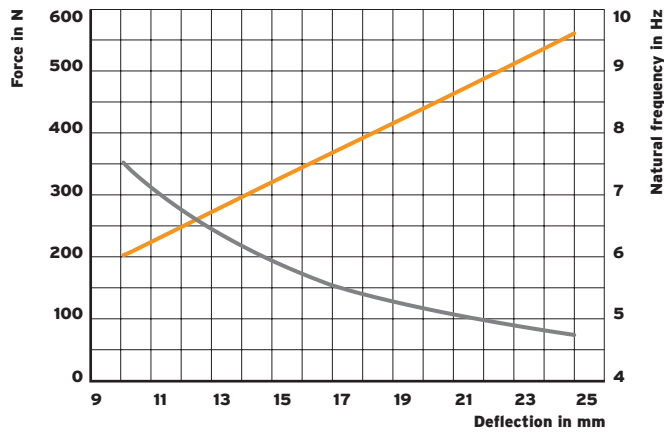

### Isotop® DSD 4

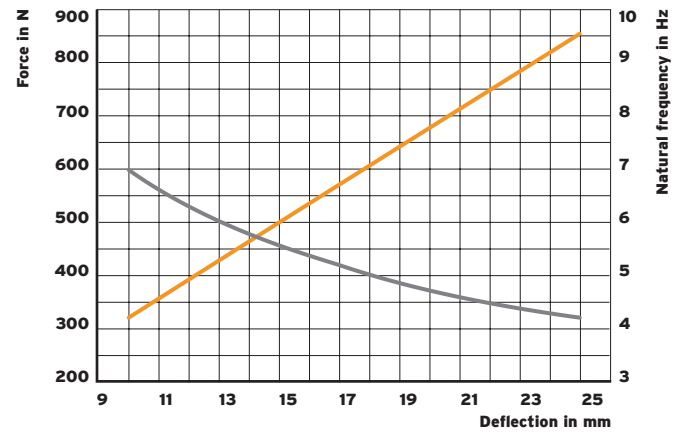

### Isotop® DSD 5

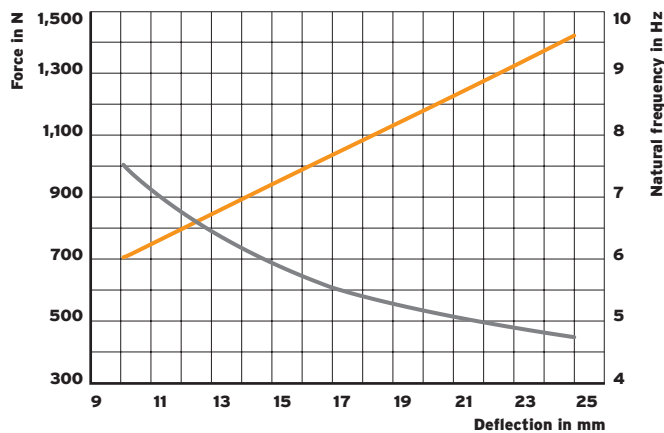

### Isotop® DSD 6

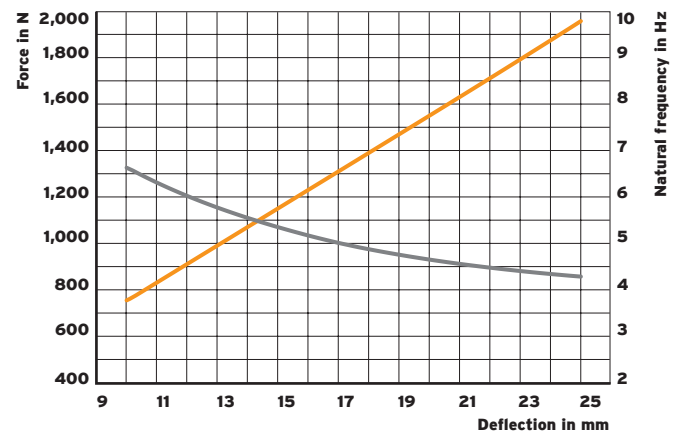

### Isotop® DSD 7

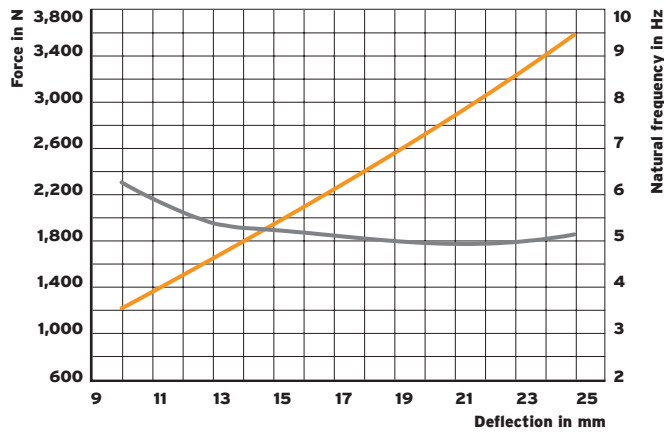

### Isotop® DSD 8

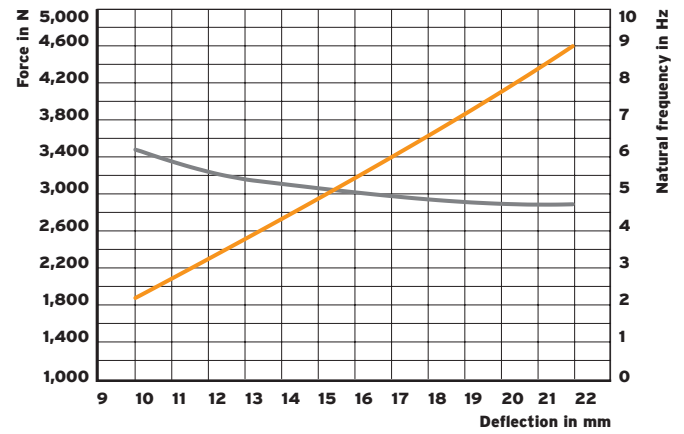

### Isotop® DSD 9

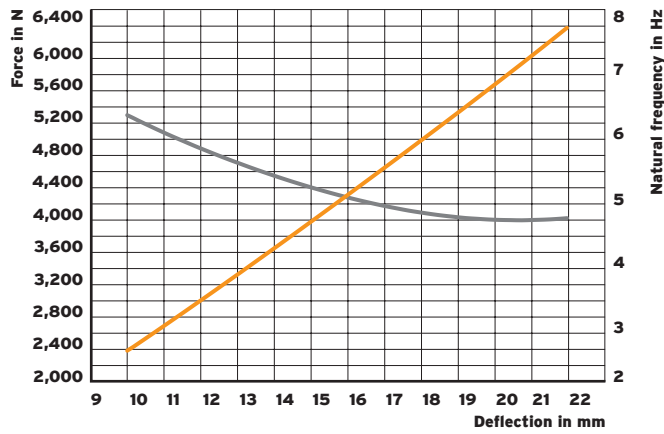

— Force in N  
 — Natural frequency in Hz

# ISOTOP® DMSN



## Isotop® type overview

Static application range

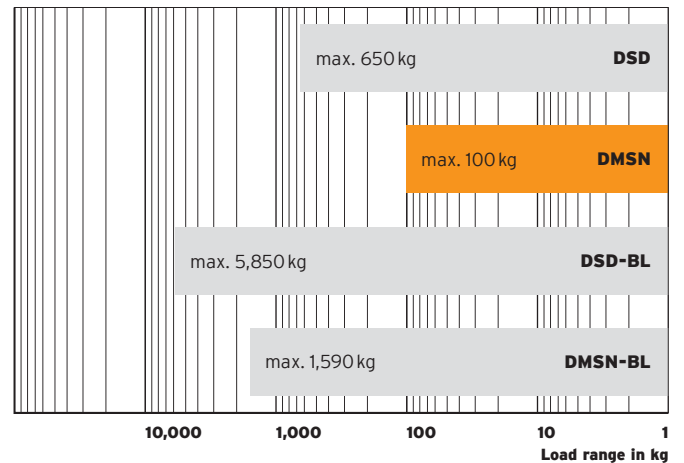

## Description

<b>Category</b>	Steel spring with damper core Design conforms to DIN EN 13906-1
<b>Material</b>	Metal caps made of steel, spring steel, 37.5 mm Sylodamp® damper core
<b>Dimensions</b>	H 57 mm / D 52 mm

## Product characteristics

<b>Natural frequency from</b>	5.3 Hz
<b>Load range</b>	0-100 kg / 987 N
<b>Overall height, unloaded</b>	57 mm
<b>Connection thread</b>	M8 internal thread
<b>Coating</b>	Cathodic dip-painted
<b>Permissible temperature range</b>	-30°C to +70°C
<b>Suitable accessories</b>	Isotop® NV 1-8 MSN



[getzner.com/  
spring-mounts-dampercore](https://www.getzner.com/spring-mounts-dampercore)

**Isotop® DMSN**  
(unloaded)

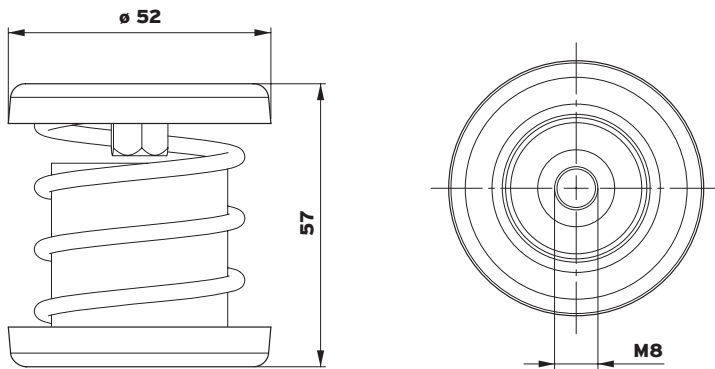

**Isotop® NV 1-8 MSN**

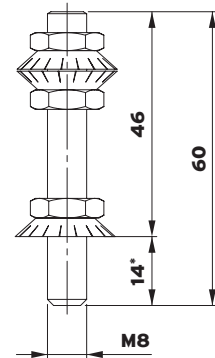

\* Thread reach MSN/DMSN

**Isotop® DMSN 3**

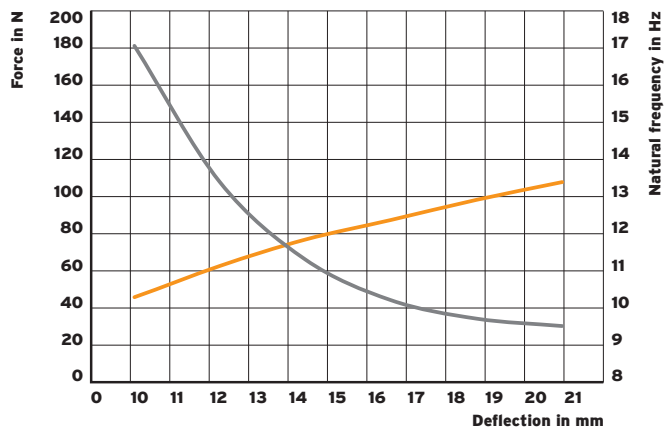

**Isotop® DMSN 4**

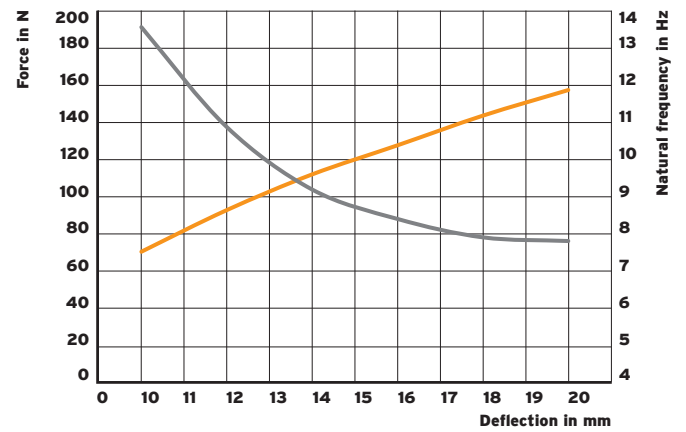

**Isotop® DMSN 5**

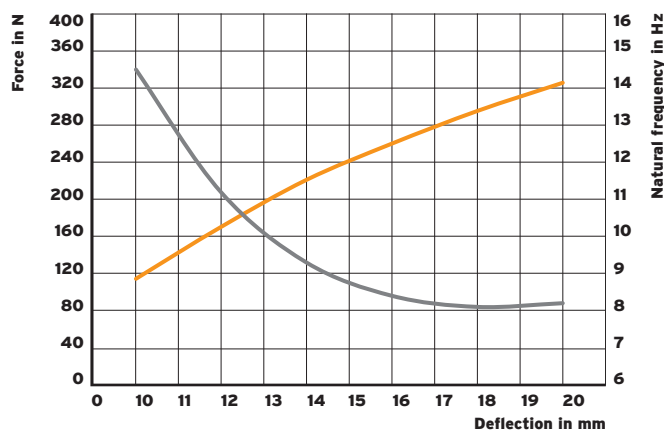

**Isotop® DMSN 6**

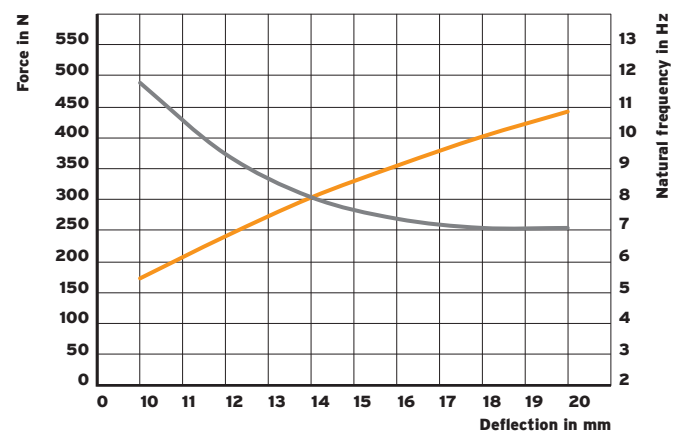

**Isotop® DMSN 7**

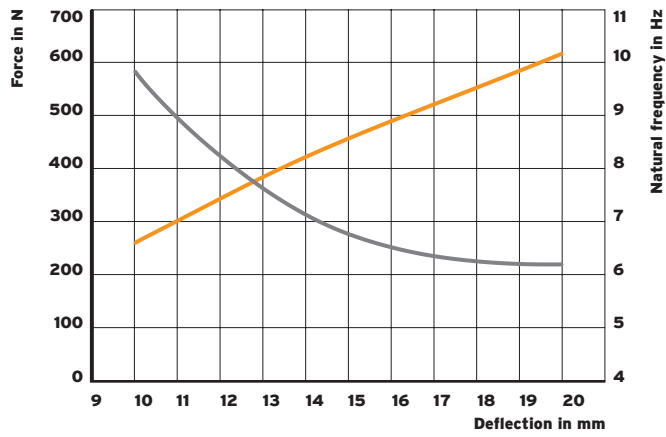

**Isotop® DMSN 8**

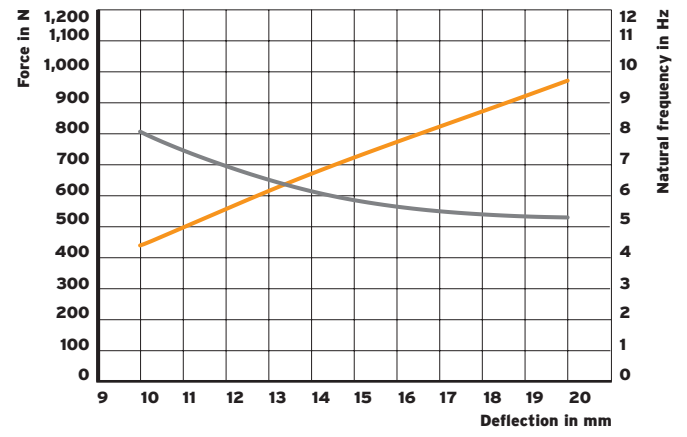

— Force in N  
 — Natural frequency in Hz



# ISOTOP® DSD-BL



## Isotop® type overview

Static application range

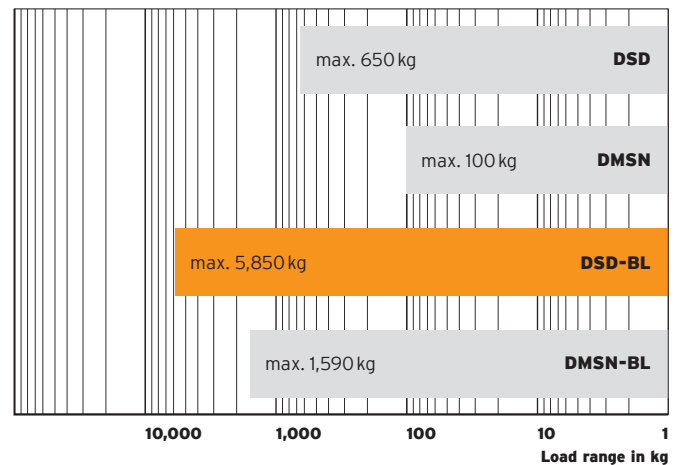

## Description

<b>Category</b>	Steel spring with damper core Design conforms to DIN EN 13906-1
<b>Material</b>	4 mm Sylomer® anti-slip plates Metal caps made of steel Spring steel 75 mm Sylodamp® damper core 6 mm steel pressure plates
<b>Dimensions</b>	As per drawing

## Product characteristics

<b>Natural frequency from</b>	4.2 Hz
<b>Load range</b>	0-5,850 kg / 57,389 N
<b>Overall height, unloaded</b>	114 mm
<b>Connection thread</b>	M12 internal thread
<b>Coating</b>	Cathodic dip-painted springs Powder-coated pressure plates
<b>Permissible temperature range</b>	-30°C to +70°C
<b>Suitable accessories</b>	Isotop® DT (SD-BL 2 and SD-BL 4)



[getzner.com/  
spring-mounts-dampercore](https://www.getzner.com/spring-mounts-dampercore)

by getzner  
**isotop**®

**Isotop® DSD-BL 2**

(unloaded)

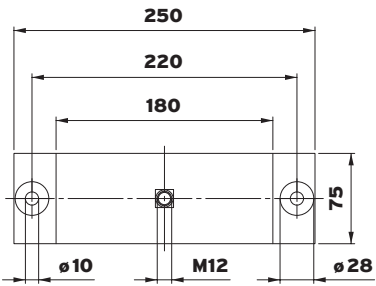
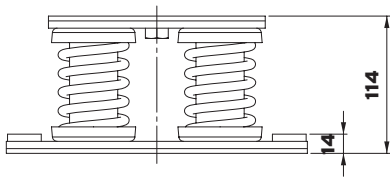

**Isotop® DSD-BL 4**

(unloaded)

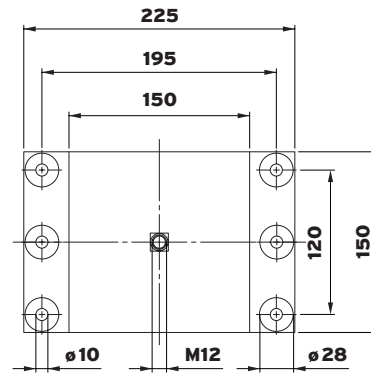
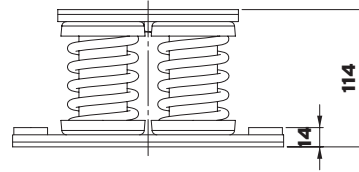

**Isotop® DSD-BL 6**

(unloaded)

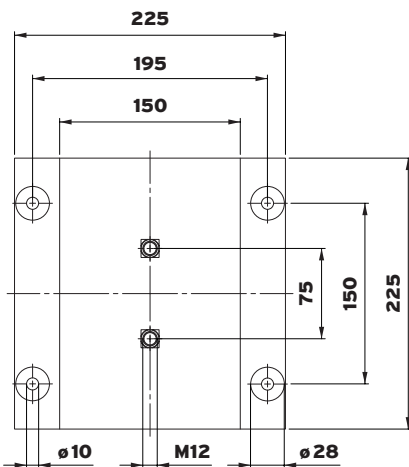
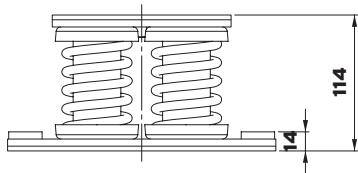

**Isotop® DSD-BL 9**

(unloaded)

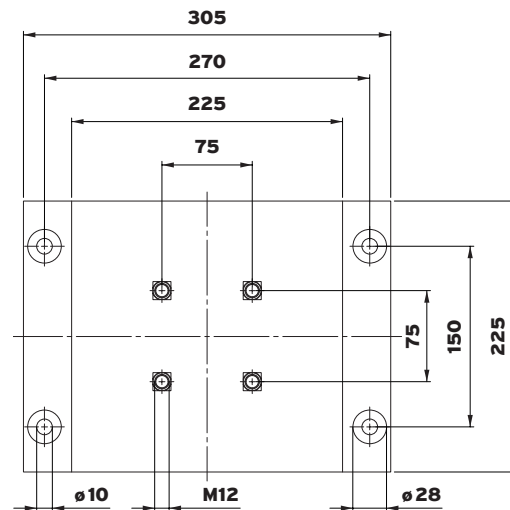
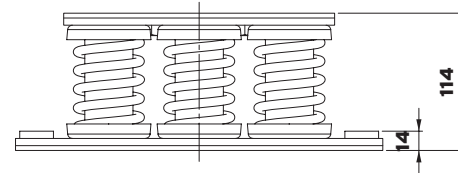

**Isotop® DSD-BL2**

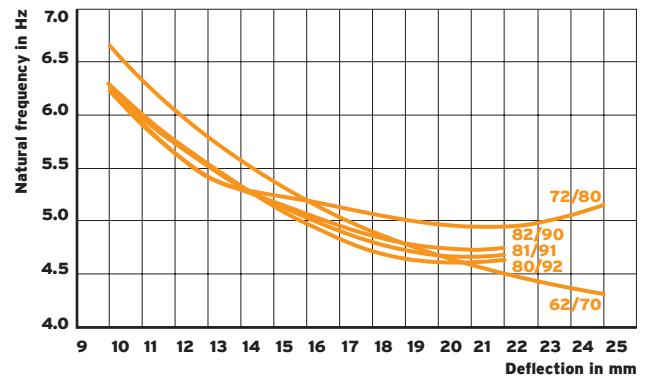
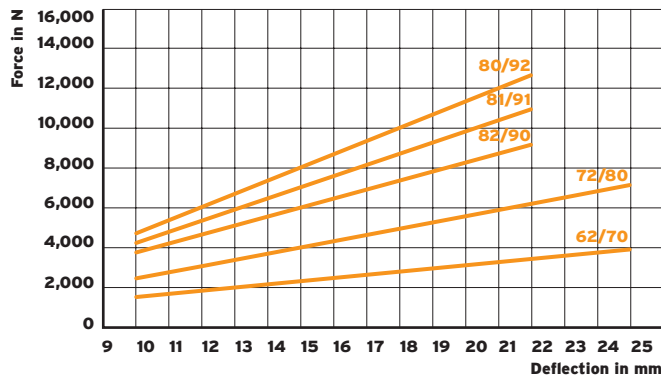

**Isotop® DSD-BL4**

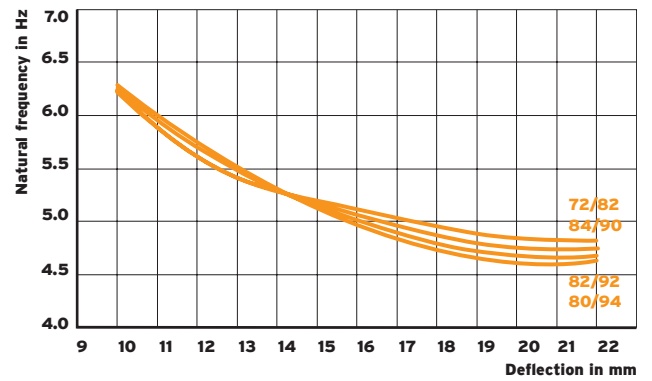
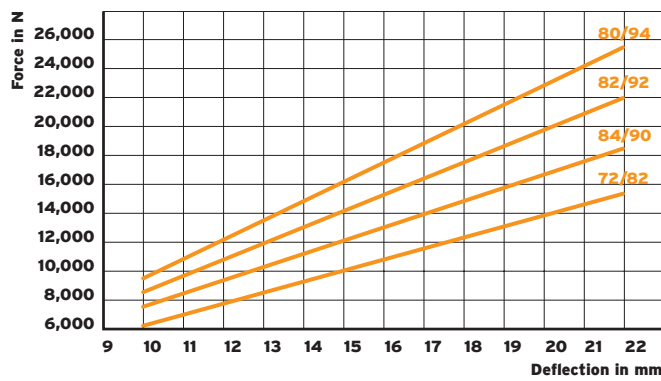

**Isotop® DSD-BL6 und DSD-BL9**

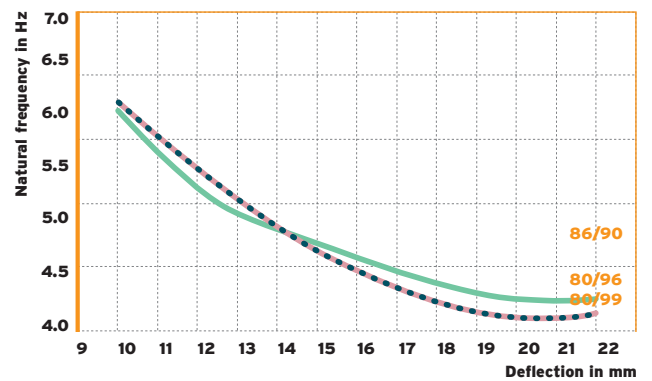
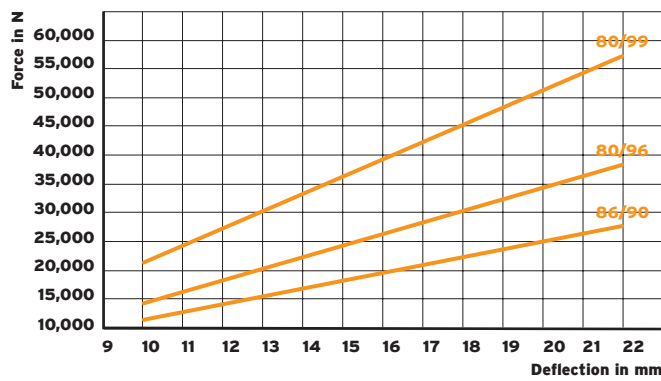

# ISOTOP® DMSN-BL



## Isotop® type overview

Static application range

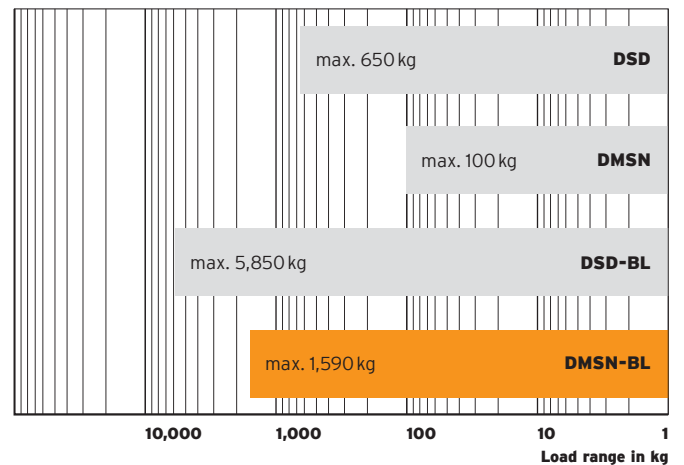

## Description

<b>Category</b>	Steel spring with damper core Custom version available
<b>Material</b>	4 mm Sylomer® anti-slip plates Metal caps made of steel Spring steel 37.5 mm Sylodamp® damper core 5 mm steel pressure plates
<b>Dimensions</b>	As per drawing

## Produkteigenschaften

<b>Natural frequency from</b>	5.3 Hz
<b>Load range</b>	0-1,590 kg / 15,598 N
<b>Overall height, unloaded</b>	75 mm
<b>Connection thread</b>	M10 internal thread
<b>Coating</b>	Cathodic dip-painted springs Powder-coated pressure plates
<b>Permissible temperature range</b>	-30°C to +70°C
<b>Suitable accessories</b>	–



[getzner.com/  
spring-mounts-dampercore](https://www.getzner.com/spring-mounts-dampercore)

**Isotop® DMSN-BL 4**

(unloaded)

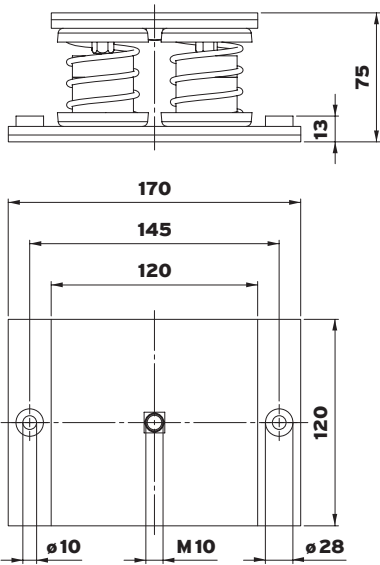

**Isotop® DMSN-BL 6**

(unloaded)

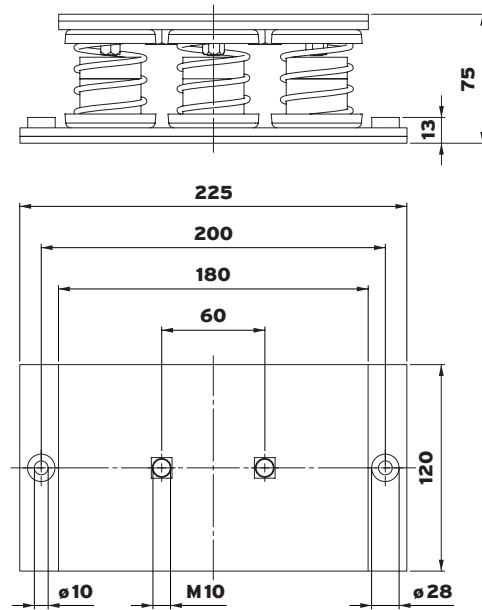

**Isotop® DMSN-BL 9**

(unloaded)

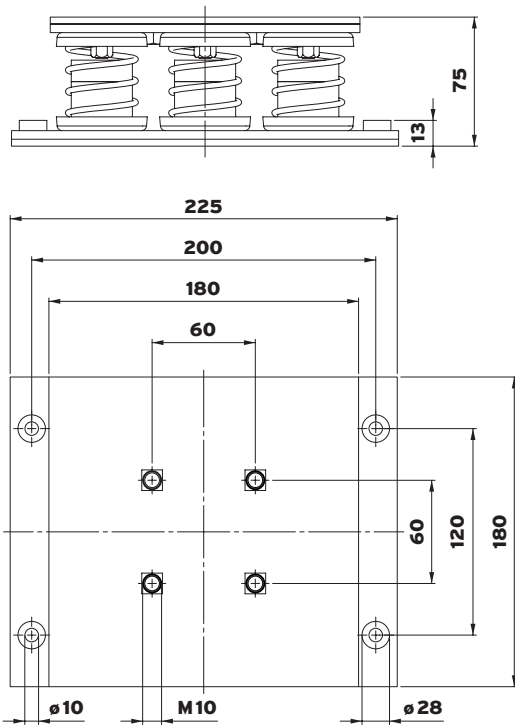

**Isotop® DMSN-BL 16**

(unloaded)

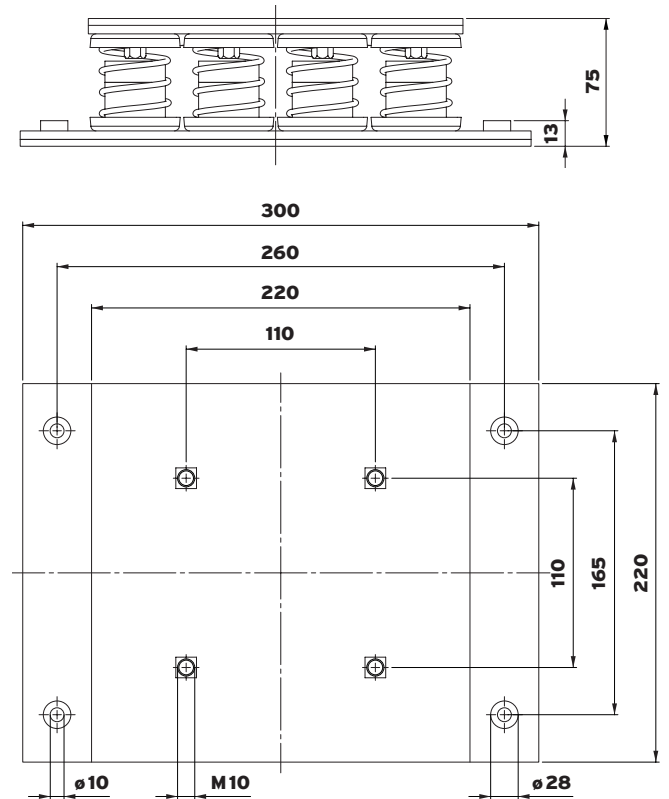

**Isotop® DMSN-BL4-62/72**

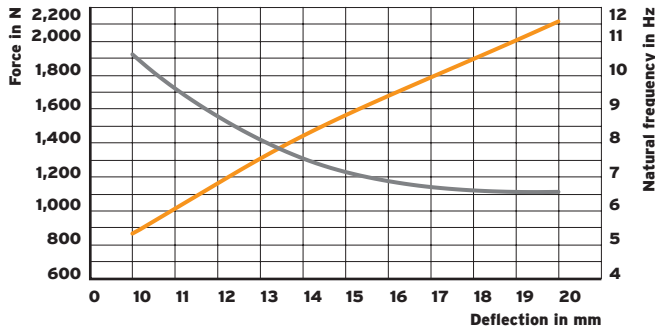

**Isotop® DMSN-BL4-70/84**

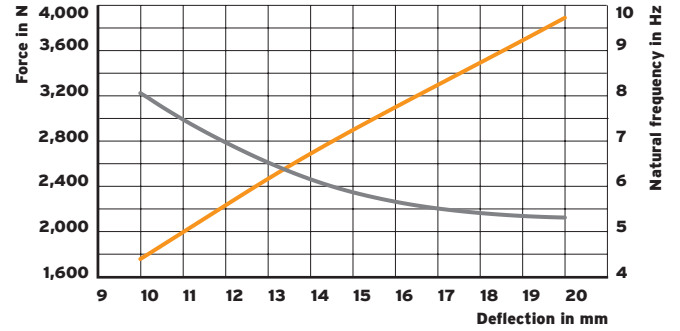

**Isotop® DMSN-BL6-72/84**

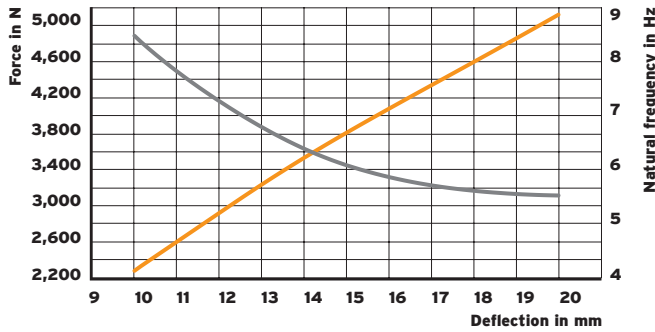

**Isotop® DMSN-BL9-74/85**

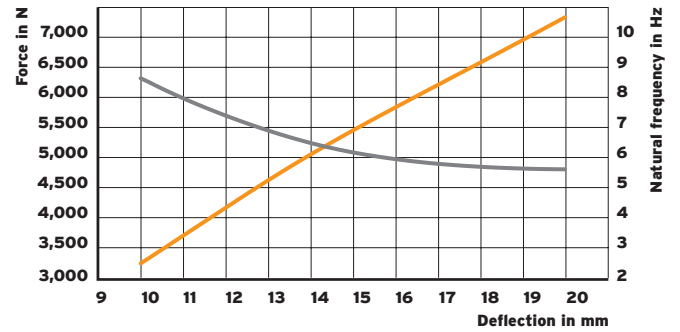

**Isotop® DMSN-BL9-70/89**

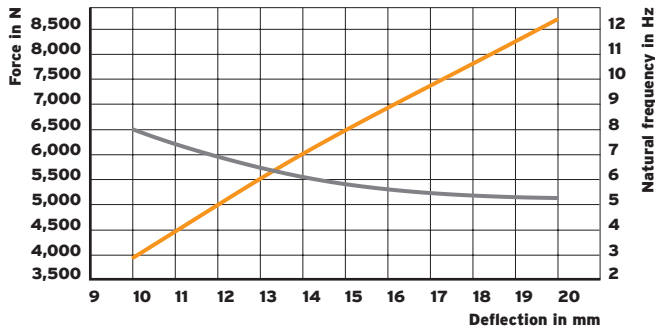

**Isotop® DMSN-BL16-712/804**

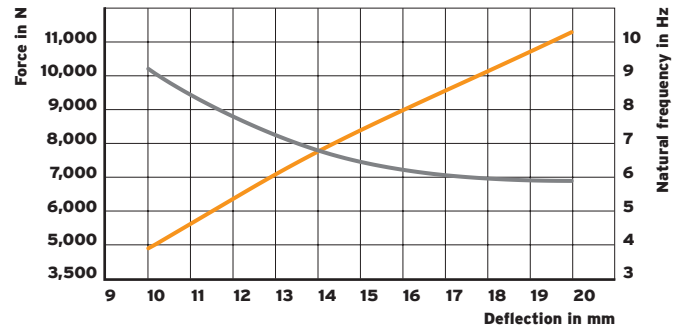

**Isotop® DMSN-BL16-700/816**

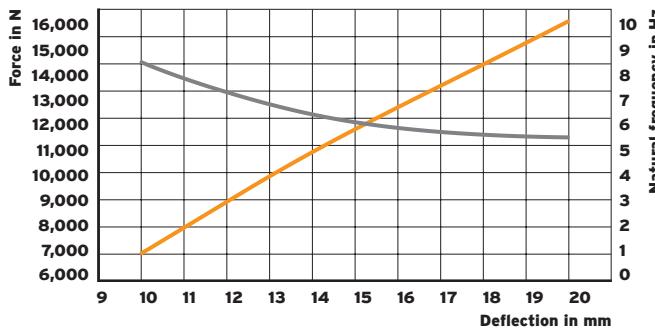

— Force in N  
— Natural frequency in Hz