





# Isotop® MSN-DAMP

## Vibration damper with metal caps and threaded fastening

- Natural frequency from 7.9 Hz
- Low overall height of 45 mm (T/T version)
- Sylomer® inside
- Cathodic dip-coated (CDC) metal caps for increased corrosion protection
- Secure connection between the plate and the polyurethane damper thanks to special adhesive
- M8 internal thread and/or M8 stud bolts for easy screw-fixing
- Available in three different attachment options

		Maximum load		Natural frequency at maximum load	Packaging unit	Order number
		in kg	in N			
<b>MSN-DAMP T/T</b> 	Isotop® MSN-DAMP-110 T/T	10	103	8.8 Hz	50 pcs.	<b>39501</b>
	Isotop® MSN-DAMP-170 T/T	18	185	7.9 Hz	50 pcs.	<b>39502</b>
	Isotop® MSN-DAMP-350 T/T	35	343	8.1 Hz	50 pcs.	<b>39503</b>
<b>MSN-DAMP B/T</b> 	Isotop® MSN-DAMP-110 B/T	10	103	8.8 Hz	50 pcs.	<b>41715</b>
	Isotop® MSN-DAMP-170 B/T	18	185	7.9 Hz	50 pcs.	<b>41716</b>
	Isotop® MSN-DAMP-350 B/T	35	343	8.1 Hz	50 pcs.	<b>41717</b>
<b>MSN-DAMP B/B</b> 	Isotop® MSN-DAMP-110 B/B	10	103	8.8 Hz	50 pcs.	<b>41720</b>
	Isotop® MSN-DAMP-170 B/B	18	185	7.9 Hz	50 pcs.	<b>41721</b>
	Isotop® MSN-DAMP-350 B/B	35	343	8.1 Hz	50 pcs.	<b>41722</b>

Isotop® MSN-DAMP T/T (unladen)

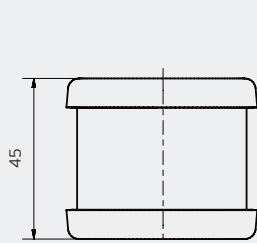

Isotop® MSN-DAMP B/T (unladen)

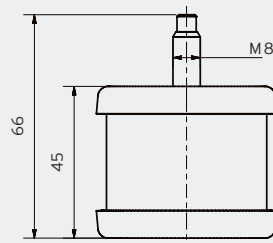

Isotop® MSN-DAMP B/B (unladen)

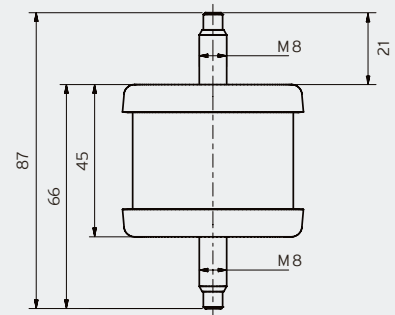

Thread reach into the internal thread max. approx. 15 mm plus material thickness of device frame

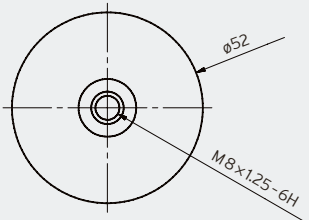



Bearing of a compressor assembly on an internal frame



Compressor bearing concept with Sylomer® CGR and Isotop® MSN-DAMP

### Isotop® MSN-DAMP 110

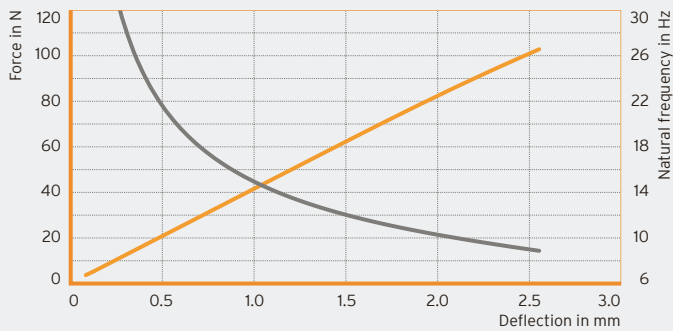

### Isotop® MSN-DAMP 170

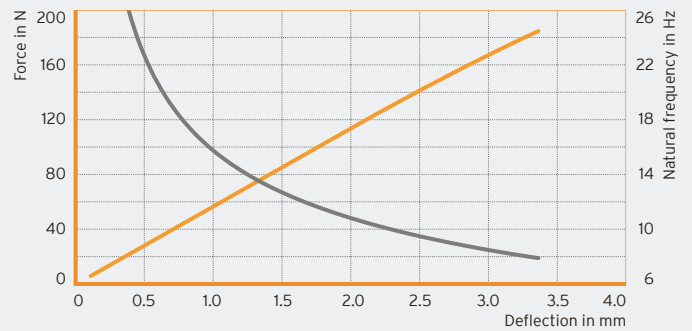

### Isotop® MSN-DAMP 350

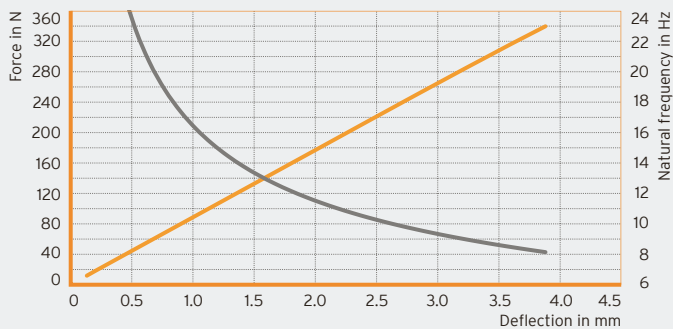

— Force in N  
— Natural frequency in Hz

DB Isotop® en © Copyright by Getzner Werkstoffe GmbH | 05-2020 | All information and data is based on our current knowledge. The data can be applied for calculations and as guidelines, are subject to typical manufacturing tolerances and are not guaranteed. Material properties as well as their tolerances can vary depending on type of application or use and are available from Getzner on request. Further information can be found in VDI Guideline 2062 (Association of German Engineers) as well as in glossary. Further characteristic values on request.