

DECOUPLING OF FLANKING SOUND



- Highly effective sound decoupling with Syldyn®
- Approved static certification (abZ): Z-16.8-468
- Comprehensive system solutions from bearing to fastener

INNOVATIVE SOUND CONTROL
with Syldyn® for the Timber Construction Sector

getzner

**ELASTIC BEAR-
ING IN TIMBER
CONSTRUCTION.**



[getzner.com/
timber](https://getzner.com/timber)

STICK WITH WHAT WORKS AND WELCOME WHAT'S NEW



Time and cost savings



Low dead weight



Negative CO₂ balance

Building projects, and therefore the planners and companies carrying out the construction work, have faced steadily increasing requirements in recent years. As a result, timber construction is proving to be particularly innovative. Cost savings through short construction times and precise pre-fabrication, a reduction in grey energy through the increased use of raw materials with a negative CO₂ balance, flexible planning thanks to low dead weights, as well as digitalisation in project planning and in manufacturing, are just a few of the key areas at present.

At the same time, smart solutions to the requirements placed on the statics, fire protection, and even sound control, are being found as a result of the ongoing development of planning methodologies and increasingly innovative products.

Getzner Werkstoffe has for many decades now been providing active support with its expertise and its Sylodyn® and Sylomer® products.

COMFORT IS MORE THAN JUST A MINIMUM OF SOUND CONTROL

Defining the requirements

Choosing the correct target value is a prerequisite for optimum project planning in the area of sound control. This is normally chosen according to national standards or guidelines. The minimum requirements specified in these standards only rarely satisfy the expectations of the residents who will be living in the property in the future. On the one hand, this is because the subjective response to someone walking around in the room above can only be replicated to a limited extent using standard parameters and, on the other hand, because some countries use component parameters as planning values, which sheds very little light on the actual conditions in the room. Getzner therefore recommends discussing and defining the desired sound control level with the future residents in advance.

The appropriate sound control level

To help choose the right sound control level, various associations have developed categories that allow a more precise selection to be made. As well as defining various classes, an attempt has also been made to represent the subjective perception. As perception differs from person to person, the comparison shown in Table 2 has to be seen purely as a guideline.

Additional classifications exist that lend themselves to the definition of the sound control level. The classification shown in the tables below is based on DEGA recommendation 103-1 (2024-09)¹.

	F	E	D	C	B	A	A*
Impact noise protection $L'_{n,w}$	> 60 dB	≤ 60 dB	≤ 53 dB	≤ 46 dB	≤ 39 dB	≤ 37 ²⁾ dB	≤ 30 ²⁾ dB
Airborne sound ¹⁾ R'_w	< 51 dB	≥ 51 dB	≥ 54 dB	≥ 57 dB	≥ 62 dB	≥ 67 dB	≥ 72 dB

¹⁾ Rated building sound reduction index, vertical
²⁾ incl. spectrum adaptation terms $C_{1,50-2500}$

Tab. 1: DEGA recommendation 103-1 (2024-09) for the sound insulation of ceilings and walls

Walking noises	Very clearly audible	Clearly audible	Audible	Still audible	Not audible	Not audible
Loud speech	Very intelligible, very clearly audible	Very intelligible, clearly audible	Partly intelligible, in general audible	In general, not intelligible, partly audible	Not intelligible, still audible	Not intelligible, not audible

Tab. 2: DEGA recommendation 103-1 (2024-09) noise perception

¹ Austrian Standard B8115-5, Sound control and room acoustics in buildings - Part 5: Classification; VDI 4100, Sound insulation between room in buildings - Dwellings - Assessment and proposals for enhanced sound insulation between rooms; DEGA Recommendation 103-1 (2024-09), Sound insulation in housebuilding - sound insulation certificate; SS 25267, Building acoustics - Sound classification of spaces in buildings - Housing; ISO FDIS 19488, Acoustics - Acoustic classification of dwellings

SOUND

Sound is a physical phenomenon. It describes a mechanical vibration that emanates from a source and is distributed via a medium by causing the mass particles to become agitated.

Rated sound reduction index R

The rated sound reduction index R describes the difference in level between two rooms and hence the sound insulating characteristics of a partitioning element. This value can only be tested in the laboratory. Other transmission paths exist that will affect the level in the receiving room. This is referred to as the construction rated sound reduction index R' . The higher the difference in level, the better the soundproofing properties of the component.

$$R' = L_1 - L_2 + 10 \log \left(\frac{S_s}{A} \right)$$

- L_1 Mean level in transmitting room
- L_2 Mean level in receiving room
- S_s Area of partitioning element in m^2
- A Equivalent absorption area in receiving room in m^2

Sound level difference D

The standard sound level difference D_{nT} describes not just the sound attenuation between two rooms, it also considers room characteristics such as reverberation time and room volume. The relationship between the variables R' and D_{nT} is described as follows.

$$D_{nT} = R' + 10 \log \left(\frac{0,16V}{T_0 S_s} \right) = R' + 10 \log \left(\frac{0,32V}{S_s} \right)$$

- V Volume of receiving room in m^3
- T_0 Reference reverberation time 0,5 s

Impact noise level L

The normalised impact noise level L_n describes the level of a separating ceiling which is artificially agitated by using a standard hammer mill. The lower the measured level, the better the impact noise insulation properties of the separating ceiling.

$$L'_n = L_i + 10 \log \left(\frac{A}{A_0} \right)$$

- L_i Mean level in receiving room
- T_0 Reference absorption area, $A_0 = 10 m^2$

The relationship between the normalised impact noise level L'_n and the standard impact noise level L'_{nT} is described as follows.

$$L'_{nT} = L'_n - 10 \log \left(\frac{0,16V}{A_0 T_0} \right) = L'_n - 10 \log (0,032 V)$$

LOW-FREQUENCY IMPACT NOISE



Low-frequency impact noise $L_{nTw} + C_{1,50-2500}$

Project requirements for impact sound are often defined in L'_{nw} or L_{nTw} , which cover frequencies from 100 to 3150 Hz. Especially when walking, people cause relevant sound in the lower frequency range. These are better taken into account using the test parameter $L_{nTw} + C_{1,50-2500}$. The published DEGA Guideline 301-01 therefore shows that increased sound insulation classes A and A* must include low frequencies. For this reason, Getzner the extended range, for example in the online calculation tool FloorCalc.

$$L_{nTw} + C_{1,50-2500}$$

L_{nTw} Computed standard impact noise level
 $C_{1,50-2500}$ Spectrum adaptation value

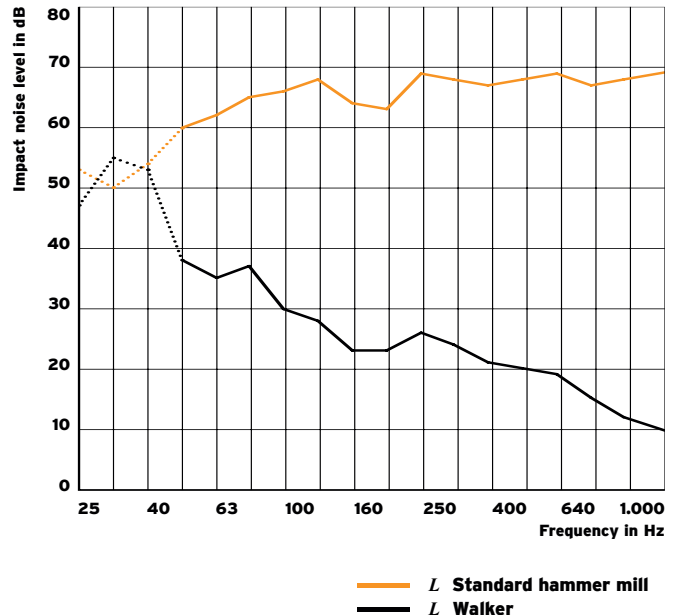

FLANKING TRANSMISSION PATHS

In addition to the direct transmission path through the partitioning element itself, a significant amount of the acoustic energy is also transmitted via the adjacent flanking components. There are therefore different initiating and radiating scenarios depending on the excitation. The sum of the transmission paths then gives the rated sound reduction index R' for the building and the total impact noise level $L'_{n,w}$. The computation for the individual transmission paths is based on EN 12354-1 and EN 12354-2.²

As the quality of the ceiling component improves, the greater the effect of the flanking. This can be exemplified using the correction value K as per DIN 4109, which, depending on the implementation, can deviate significantly from the curve (see page 6). In the case of impact noise, the effect of the flanking is primarily determined by the type of false ceiling, as the screed and finish of the raw ceiling can both contribute towards an improvement in the transmission paths Dd and Df .

The following equations can be used for the individual transmission paths:

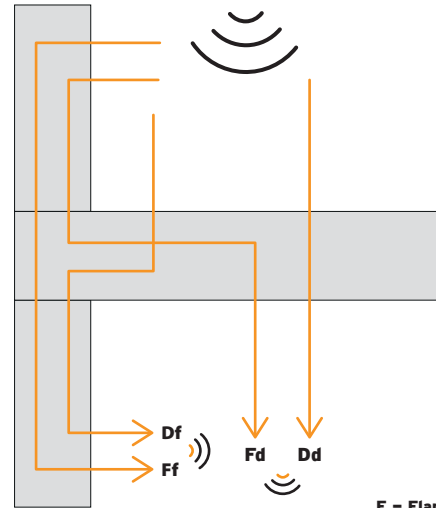

F – Flank excited
D – Directly excited
f – Flank radiated
d – Directly radiated

Airborne sound transmission as per EN12354-1

$$R_{ij,w} = \left(\frac{R_{i,w} + R_{j,w}}{2} \right) + \Delta R_{ij,w} + K_{ij} + 10 \log \frac{S_S}{l_0 l_{ij}} \text{ dB}$$

$$R'_w = -10 \log \left(10 \frac{-R_{Dd,w}}{10} + \sum 10 \frac{-R_{Df,w}}{10} + \sum 10 \frac{-R_{Fd,w}}{10} + \sum 10 \frac{-R_{Ff,w}}{10} \right) \text{ dB}$$

$R_{ij,w}$ Computed flanking sound reduction index for the transmission path ij
 $R_{i,w}$ Computed rated sound reduction index of the initiating component i
 $R_{j,w}$ Computed rated sound reduction index of the radiating component j
 $\Delta R_{ij,w}$ Overall improvement in airborne noise reduction index through the use of additional constructions in the transmitting and receiving rooms of the flanking component

$R_{ij,w}$ Computed overall flanking sound reduction index
 K_{ij} Vibration reduction index for the transmission path ij
 S_S Area of partitioning element
 l_0 Reference coupling length, $l_0 = 1\text{m}$
 l_{ij} Combined coupling length of the component i and j

Impact noise transmission as per EN12354-2

$$L_{n,ij,w} = L_{n,eq,0,w} - \Delta L_w + \frac{R_{i,w} - R_{j,w}}{2} + \Delta R_{ij,w} - K_{ij} - 10 \log \frac{S_i}{l_0 l_{ij}} \text{ dB}$$

$$L'_{n,w} = 10 \log \left(10 \frac{L_{n,d,w}}{10} + \sum 10 \frac{L_{n,Df,w}}{10} \right) \text{ dB}$$

$L_{n,ij,w}$ Computed normalised impact noise level for the transmission path
 $L_{n,w}$ Computed overall normalised impact noise level
 $L_{n,eq,0,w}$ Equivalent computed normalised impact noise level of the raw ceiling
 ΔL_w Computed impact noise reduction of floor covering in the transmitting room
 S_i Ceiling area

² EN 12354-1, Building acoustics - Estimation of acoustic performance of buildings from the performance of elements - Part 1: Airborne sound insulation between rooms
 EN 12354-2, Building acoustics - Estimation of acoustic performance of buildings from the performance of elements - Part 2: Impact sound insulation between rooms;
 DIN 4109, Sound insulation in buildings, requirements and verification

VIBRATION REDUCTION INDEX



The vibration reduction index K_{ij} has a key role in transmission via flanking elements. It provides information about the quality of the acoustic coupling of a component joint. The higher the K_{ij} value, the less sound is transmitted via the joint.

Getzner has collaborated with various external testing institutes to calculate this reduction for different kinds of joints by carrying out test rig measurements according to EN ISO 10848. The K_{ij} values shown in Table 3 (page 19) can therefore be used as reliable planning values in the respective forecasting models. Note that the values have been tested with the fastening to provide realistic results.

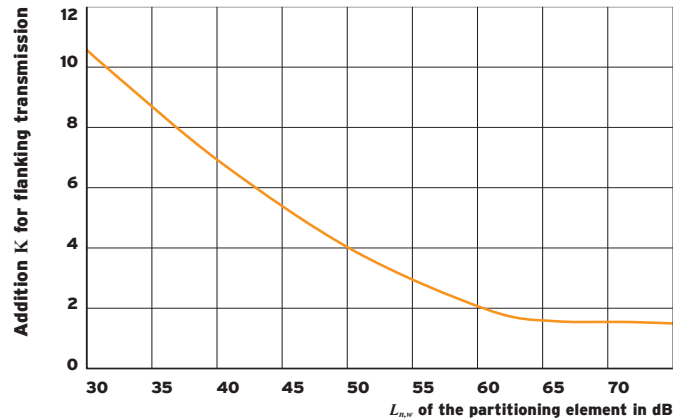

Fig. 1: Sound control in timber construction - fundamentals and initial assessment, Informationsdienst Holz

Vibration reduction index

$$K_{ij} = D_{v,ij} + 10 \log \left(\frac{l_{ij}}{\sqrt{a_i a_j}} \right)$$

- $D_{v,ij}$ Averaged velocity level difference between the initiating and radiating components in dB
- l_{ij} Combined edge length of the initiating and radiating components in m
- a_i Equivalent absorption length of the initiating component in m
- a_j Equivalent absorption length of the radiating component in m

**THE USE OF
SYLODYN® CAN
ACHIEVE ACOUSTIC
IMPROVEMENTS OF
UP TO 14 DB.**

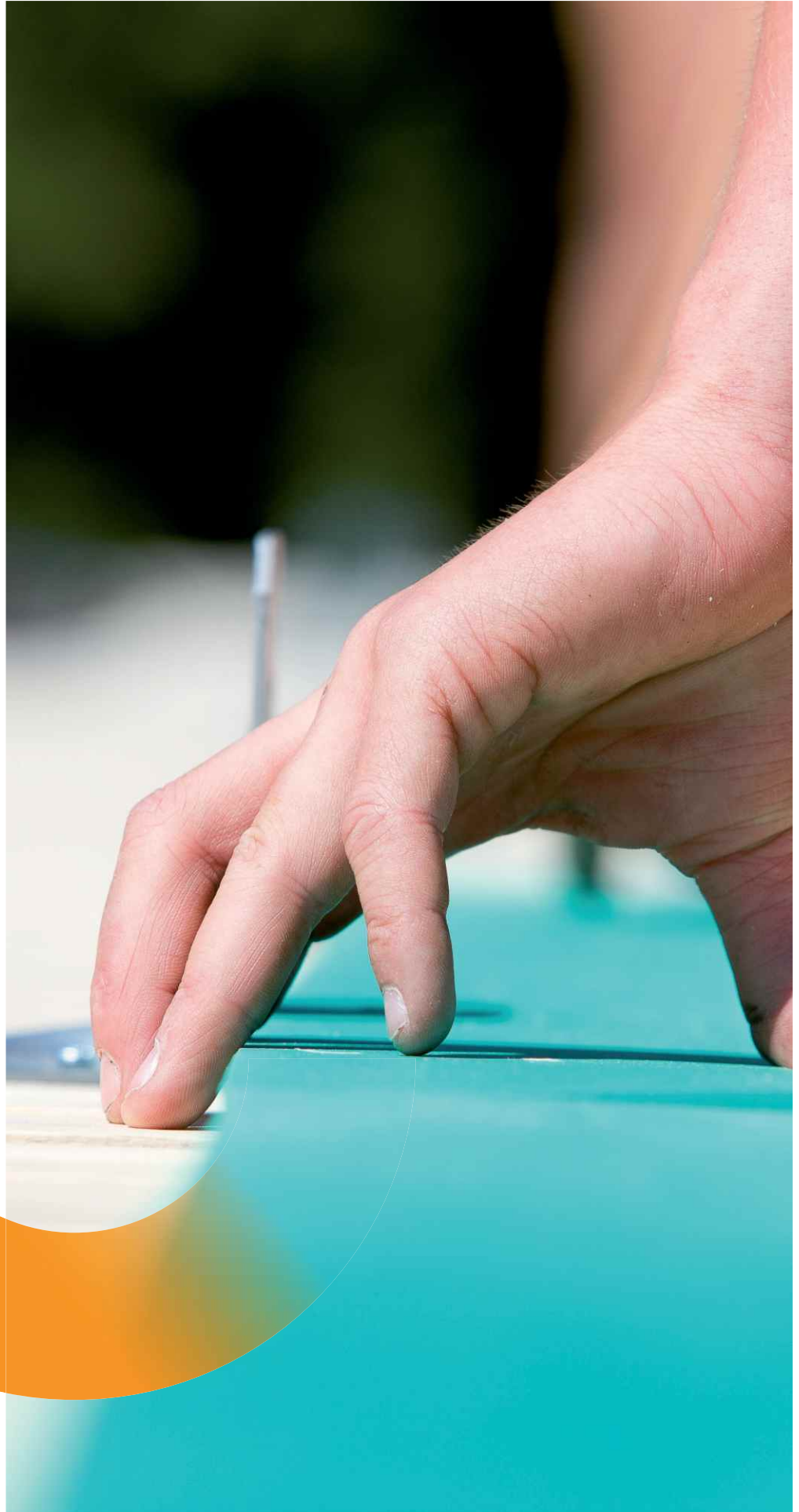

SYLODYN® - PART OF A SYSTEM SOLUTION

Product overview



Sylodyn® strip bearing

6 and 12.5 mm bearing thickness
8 bearing stiffnesses with a static range of use
of up to 12 N/mm²



GEPI angle bracket

3 types (GEPI 80, GEPI 100 and GEPI 240)



Sylodyn® washers

With and without centring aid
M8 to M27 screw diameter



Adhesive

Spray adhesive
Spray tank

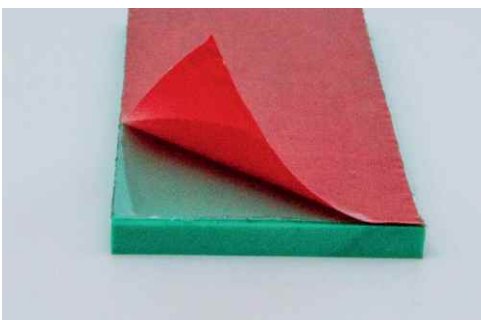

Self-adhesive version

SYLODYN® STRIP BEARING

Sylodyn® is a closed cellular polyurethane material with outstanding spring characteristics, which make it particularly suitable for the decoupling of vibration and sound. The elastic bearings are available in various degrees of stiffness and colour-coded to enable them to be identified and checked easily on site.

Ranges of use in timber construction

- Glued laminated timber (BSH)
- Cross laminated timber (CLT)
- Laminated veneer lumber (LVL)
- Hollow enclosed-section elements
- Wooden frame construction
- Modular construction
- Wood-concrete composite systems

Dimensions

- Bearings of various thickness can be selected according to the level of effectiveness required. The standard thickness for Getzner Sylodyn® materials is 12.5 mm; 6 mm and 25 mm options are available on request.
- Generally speaking, the width of the elastomer bearing depends on the wall thickness, but can be adjusted to meet a customer's requirements.
- The standard delivery length is 1,500 mm. Any remnants can be reused as required, meaning there is hardly any waste.
- Implementation: Getzner will, if required, apply a double-sided adhesive tape to its bearings prior to prefabrication in the factory.

ADVANTAGES

- Proven vibration reduction
- Compensates for unevenness
- Suitable for high loads
- Excellent long-term behaviour and high degree of ageing resistance
- Can be applied during prefabrication
- Structural analysis by means of assessment concept based on technical approval
- Negligible settlement and creep behaviour

<p>Sylodyn® NB</p> <p>0.075 N/mm²</p>	<p>Sylodyn® NC</p> <p>0.150 N/mm²</p>	<p>Sylodyn® ND</p> <p>0.350 N/mm²</p>	<p>Sylodyn® NE</p> <p>0.750 N/mm²</p>
<p>Sylodyn® NF</p> <p>1.500 N/mm²</p>	<p>Sylodyn® HRB HS 3000</p> <p>3.000 N/mm²</p>	<p>Sylodyn® HRB HS 6000</p> <p>6.000 N/mm²</p>	<p>Sylodyn® HRB HS 12000</p> <p>12.000 N/mm²</p>

ACOUSTICALLY DECOUPLED FASTENERS

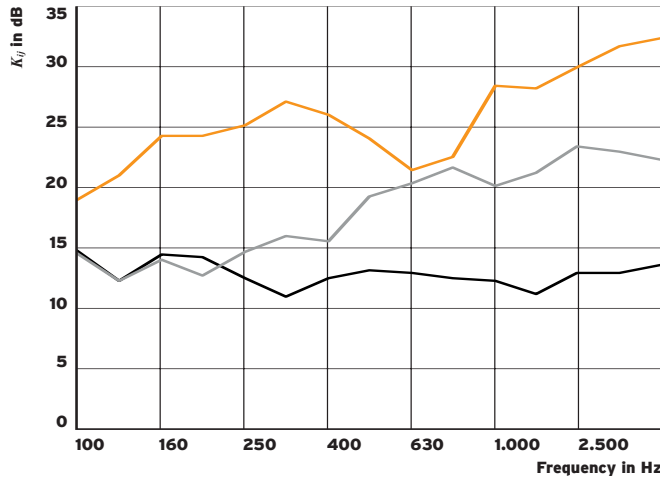

Sound bridges must be avoided during planning and implementation. This involves ensuring the right fastener is chosen. These fasteners must be acoustically optimised and statically verifiable.

For this purpose, Getzner has worked with established partners in the timber construction industry to develop solutions for corners, screw connections and plug-in connections.

Abb. 2: K_{12} Plot for a T-joint with Syldyn® and elastic fastener, Syldyn® with rigid fastener and without elastomer intermediate layer

Acoustically optimised joint detail

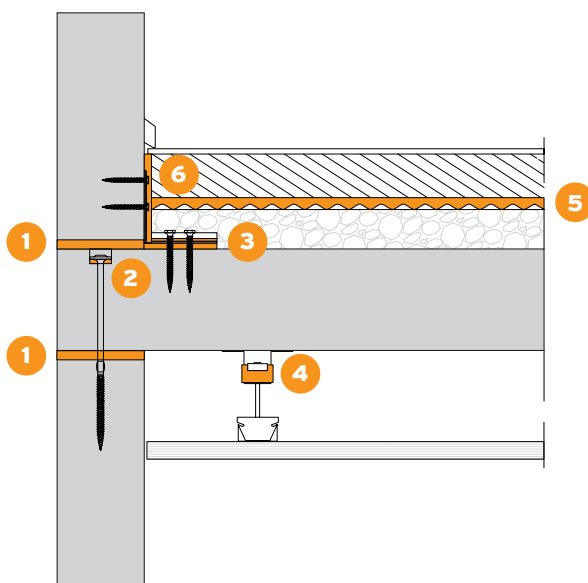

- 1 Syldyn® flank decoupling
- 2 Elastic washer
- 3 Elastic angle bracket
- 4 Akustik + Sylomer® ceiling hangers
- 5 AFM impact noise insulation
- 6 Elastic edge insulation strip

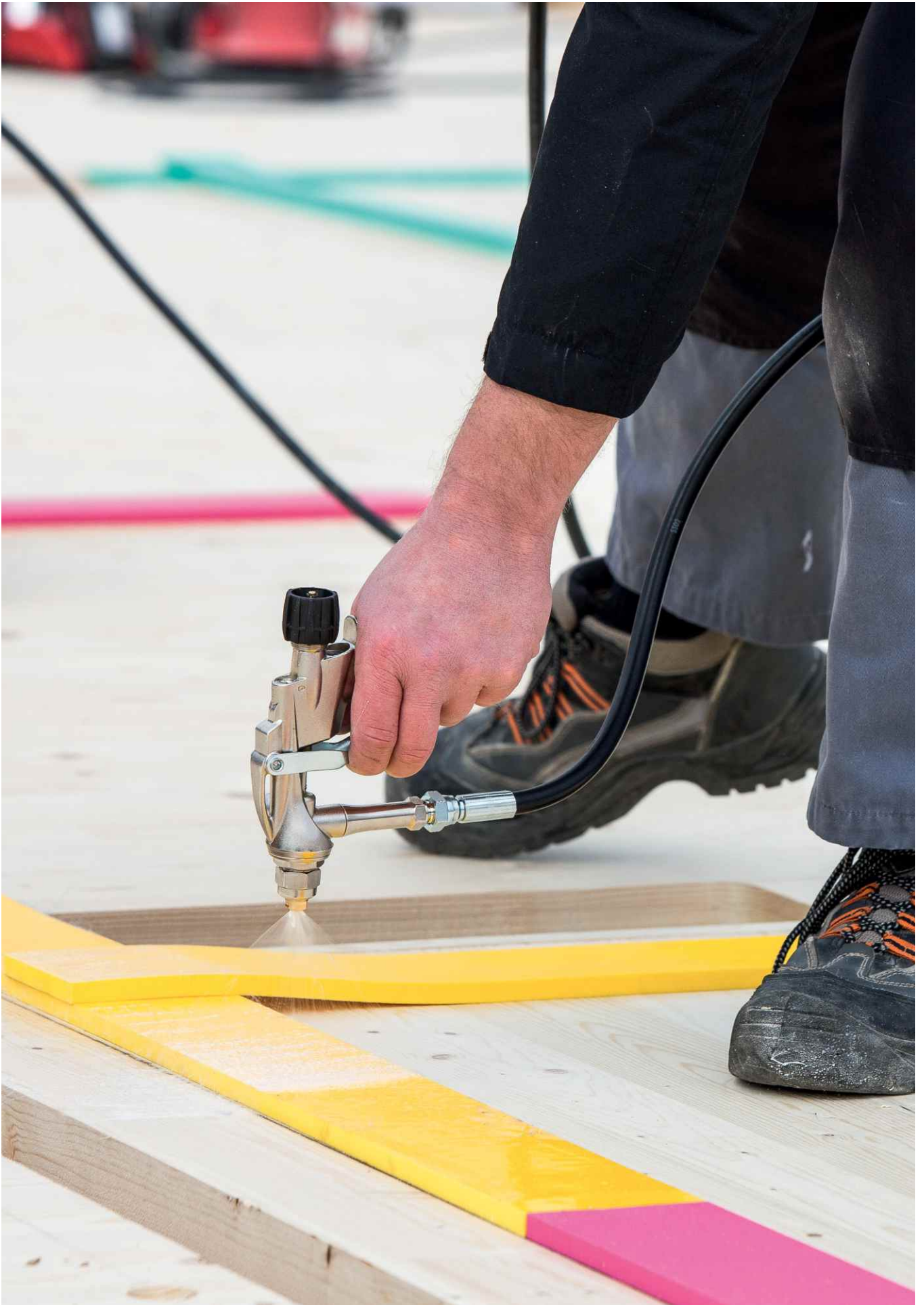

OPTIMAL ANGLE BRACKET

Among other things, two high-performance, acoustically decoupled brackets were developed in a collaboration between Pitzl Metallbau, the University of Innsbruck and Getzner Werkstoffe. These provide high levels of resistance to shear and tensile forces and verifiably prevent sound transmission via flanking elements. The three angle brackets are suitable for both timber-timber and timber-concrete connections and have European Technical Approval for a reliable structural analysis.

Dynamic studies have also examined the earthquake resistance of GEPI 240.

Installation tip

Use the assembly tool to ensure the bracket is pre-tensioned correctly.

Screws required

		Quantity	Type	Size	Thread
GEPI 80	Shank 1	3	Round-headed	8×80 mm	Partial thread
	Shank 2	2	Countersunk	8×160 mm	Full thread
GEPI 100	Shank 1	5	Round-headed	8×80 mm	Partial thread
	Shank 2	4	Countersunk	8×160 mm	Full thread
GEPI 240	Shank 1	16	Round-headed	8×80 mm	Partial thread
	Shank 2	11	Countersunk	8×160 mm	Full thread

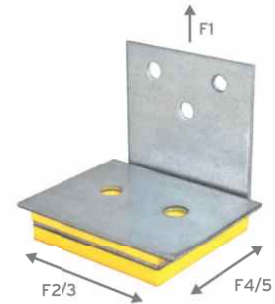

Angle bracket GEPI 80

F1 tensile	F2/3 shear	F4/5 shear	Service classes
8 kN	5 kN	5 kN	1 + 2

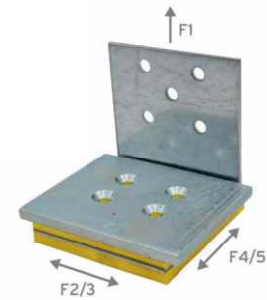

Angle bracket GEPI 100

F1 tensile	F2/3 shear	F4/5 shear	Service classes
16 kN	12 kN	12 kN	1 + 2

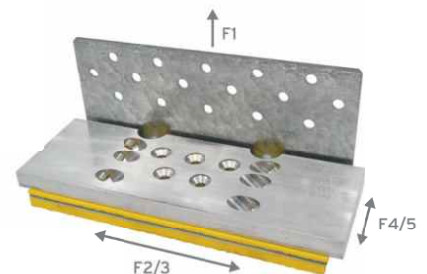

Angle bracket GEPI 240

F1 tensile	F2/3 shear	F4/5 shear	Service classes
50 kN	60 kN	12 kN	1 + 2

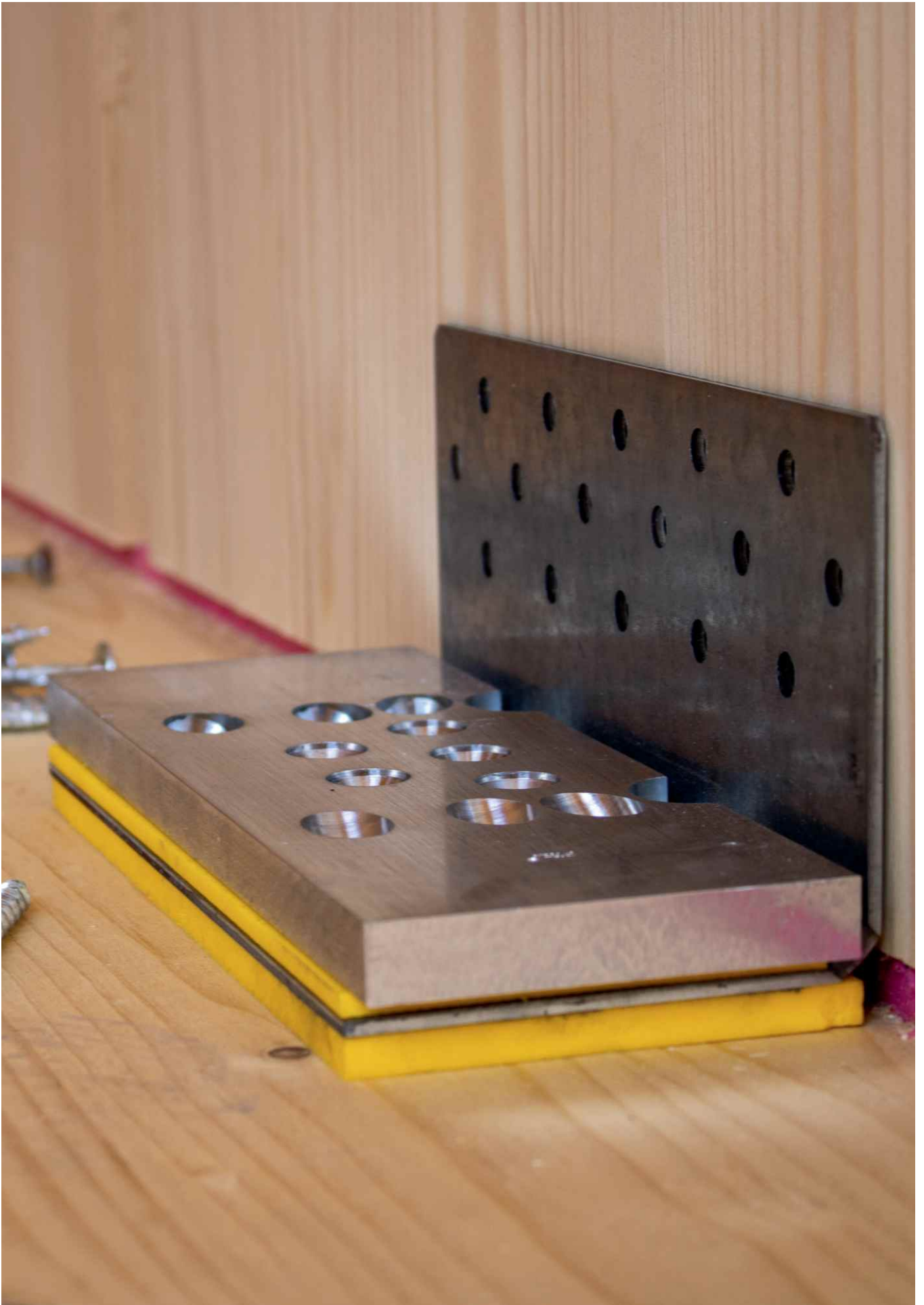

HOW TO MAKE A GOOD SCREW CONNECTION

One of the most important fasteners in timber construction is the screw connection. The avoidance of sound bridges in this area requires a clean implementation and the use of elastically decoupled washers.

Installation instructions

- Elastically decoupled screw connection should always be predrilled in the component above the bearing.
Ø predrilled hole = Ø screw thread
- Screw head and washers should be countersunk.
- Use of partially threaded screws so that the thread is only anchored in the component under the bearing.
- Elastic washers are to be used.

Packaging unit 100 pcs.



Article	Thickness	Screw size	External diameter	Hole diameter
EW M8-6	6 mm	M8	35 mm	9 mm
EW M10-6	6 mm	M10	40 mm	11 mm
EW M12-6	6 mm	M12	50 mm	13 mm
EW M16-6	6 mm	M16	55 mm	17 mm
EW M8-8	8 mm	M8	28 mm	9 mm
EW M10-8	8 mm	M10	34 mm	11 mm
EW M12-8	8 mm	M12	44 mm	13 mm
EW M16-8	8 mm	M16	56 mm	17 mm
EW M8-12	12 mm	M8	35 mm	9 mm
EW M10-12	12 mm	M10	40 mm	11 mm
EW M12-12	12 mm	M12	50 mm	13 mm
EW M16-12	12 mm	M16	55 mm	17 mm
EW M8-21	21 mm	M8	28 mm	9 mm
EW M10-21	21 mm	M10	34 mm	11 mm
EW M12-21	21 mm	M12	44 mm	13 mm
EW M16-21	21 mm	M16	56 mm	17 mm
EW M20-21	21 mm	M20	60 mm	21 mm
EW M27-21	21 mm	M24, M27	70 mm	28 mm



Fig. 4: Predrilled hole

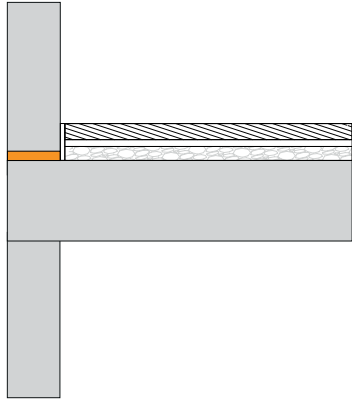

Fig. 5: Use of an elastic washer



Fig. 6: Installation

CONSTRUCTION RULES



No dry lining on the walls and
no suspended ceilings



Sylodyn® bearing above the ceiling

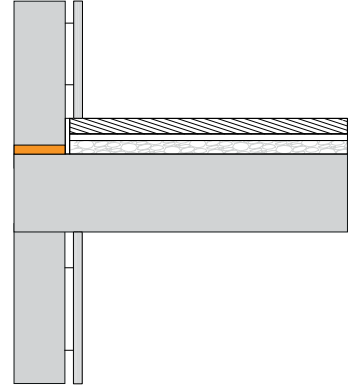

Dry lining on walls,
no suspended ceiling



Sylodyn® bearing above the ceiling

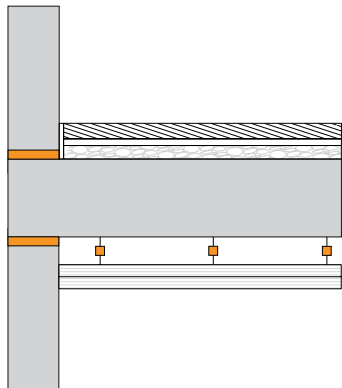

Suspended ceiling and
no dry lining on walls



Sylodyn® bearing above and below the ceiling

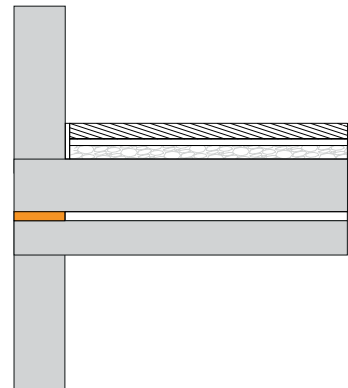

Two-shell ceiling systems and
no dry lining on the walls



Sylodyn® bearing between the ceiling components

VIBRATION REDUCTION INDEX

An elastic joint with an Sylodyn® will result in the same acoustic efficiency, than an additional dry lining layer.

Ensure that elastic decoupling is installed across the entire system. This will mean that all fasteners, such as brackets or screws, are acoustically optimised. Rigid fasteners reduce the effectiveness of the overall solution compared to bearings with elastically decoupled fasteners.

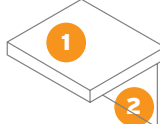
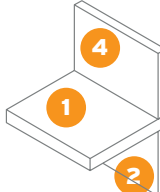
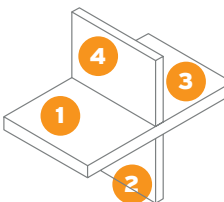
Rigid	Sylodyn® 12.5 mm incl. elastic fastener	Sylodyn® 6 mm incl. elastic fastener	Joint design
$K_{12} = 10.1 \text{ dB}$ Average value from different test rigs	$K_{12} = 23.1 \text{ dB}$ with bearing	$K_{12} = 19.2 \text{ dB}$ with bearing	
$K_{12} = 12.6 \text{ dB}$ Average value from different test rigs	$K_{12} = 24.5 \text{ dB}$ with bearing	$K_{12} = 20.6 \text{ dB}$ with bearing	
$K_{24} = 20.8 \text{ dB}$ Average value from different test rigs	$K_{24} = 33.3 \text{ dB}$ Top or bottom bearing	$K_{24} = 29.6 \text{ dB}$ Top or bottom bearing	
	$K_{24} = 35.1 \text{ dB}$ Top or bottom bearing	$K_{24} = 32.2 \text{ dB}$ Top or bottom bearing	
$K_{12} = 13.6 \text{ dB}$ Average value from different test rigs	$K_{12} = 25.5 \text{ dB}$ with bearing	$K_{12} = 20.2 \text{ dB}$ with bearing	
$K_{24} = 25.6 \text{ dB}$ Average value from different test rigs	$K_{24} = 35.8 \text{ dB}$ Top or bottom bearing	$K_{24} = 33.2 \text{ dB}$ Top or bottom bearing	
	$K_{24} = 39.0 \text{ dB}$ Top or bottom bearing	$K_{24} = 35.7 \text{ dB}$ Top or bottom bearing	
$K_{13} = 6.7 \text{ dB}$ Average value from different test rigs	$K_{13} = 3.8 \text{ dB}$ Top or bottom bearing	$K_{13} = 4.2 \text{ dB}$ Top or bottom bearing	

Tab. 3: K_{ij} values compared: rigid, Sylodyn 12.5 mm and Sylodyn 6 mm

Frequency-dependent K_i values and values for other bearing thickness and fastening solutions available on request.³

³ Teibinger, M., Dolezal, F., Matzinger, I., (2009), Deckenkonstruktionen für den Mehrgeschossigen Holzbau, Vienna [Ceiling structures for multi-story timber buildings]; Schoenwald, S., Kummer, N., Wiederin, S., Bleicher, N., Furrer, B., (2019) Application of elastic interlayers at junctions in massive timber buildings, Aachen; Measurement report STM001 ACOM Research (2020); Measurement report 5211.01299-1 EMPA (2018)

ASSESSMENT

Choice of bearing and static certification

1. Certificate of application suitability (GZG)

Getzner has defined a static range of use $\sigma_{R,perm}$ in order to achieve a dynamically optimum and lasting level of effectiveness. The quasi-permanent specific loads $\sigma_{E,quasistat}$ that impinge on the material in the long term must lie within the static range of use of the respective Sylodyn® product. This will ensure that under normal usage conditions the material is used in the correct manner and will be acoustically effective.

2. Certificate of structural safety (GZT)

An appropriate assessment concept based on national technical approval (abZ) must be used for the structural analysis in the building and construction industry. Getzner has appropriately tested and approved elastomers and an assessment concept based on this that has been verified by experts. The permissible bearing resistances $\sigma_{R,d}$ can be found in the diagram below.

Static range of use and design loads

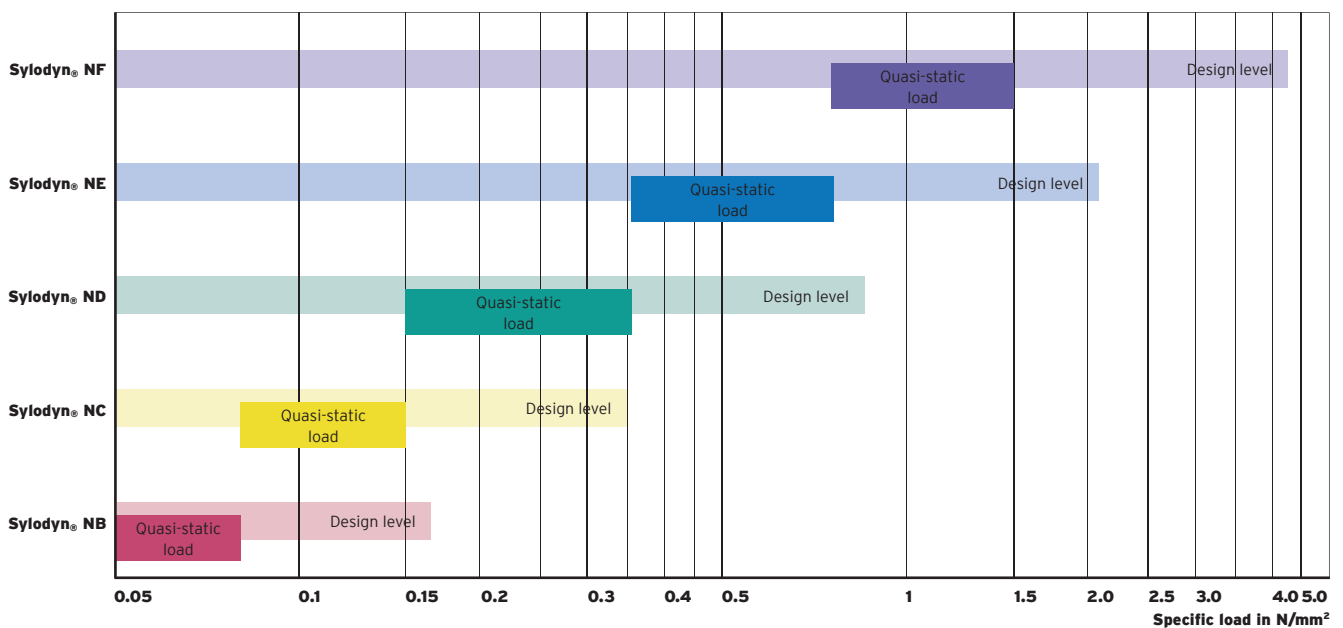

Line loads for the choice of bearing for residential buildings can be calculated in GZG as follows: $g_k + 0,3q_k$

Sylodyn® insulating strips are designed in such a way that the acoustic characteristic values on page 6 can be used when employing the materials, including elastically optimised fasteners, with the specified loads.

The design of the bearing can be determined using the free online TimberCalc tool



apps.getzner.com





TESTED AND CERTIFIED PRODUCT QUALITY



The national technical approval provides evidence of the suitability of our materials with respect to construction requirements such as reliability, durability and quality. Product-specific properties of Sylodyn®, such as creep behaviour, settlement behaviour and torsion, have been tested.

By granting approval, the Deutsches Institut für Bautechnik DIBt [German Institute for Building Technology] officially certifies that the bearings meet all the requirements for reliable use in the building and construction industry.

Certificate of vertical load transmission

$$F_{E,z,d} \leq F_{R,z,d}$$

$$F_{R,z,d} = \sigma_{R,d} \times A$$

- $D_{v,ij}$ Loaded surface of the bearing
- $F_{E,z,d}$ Vertical effect at design level
- $F_{R,z,d}$ Vertical bearing resistance at design level
- $\sigma_{R,d}$ Bearing resistance at design level according to Sylomer® and Sylodyn® assessment concept by Getzner

Non-slip certificate

$$F_{E,xy,d} \leq F_{E,z,d} \times \mu$$

- $D_{v,ij}$ Loaded surface of the bearing
- $F_{xy,d}$ Bearing reset force
- $F_{E,xy,d}$ Horizontal effect at design level
- $F_{R,xy,d}$ Horizontal bearing resistance at design level
- $F_{E,z,d}$ Vertical effect at design level
- G Shear modulus according to assessment concept
- $\epsilon_{xy,d}$ Measured shear distortion
- μ Coefficient of friction of elastomer on the adjacent component; μ values for concrete = 0.7; for steel and wood = 0.5 (or measured value)

Certificate of horizontal load transmission

$$F_{E,xy,d} \leq F_{R,xy,d}$$

$$F_{R,xy,d} = G \times A \times \epsilon_{xy,d}$$

Extract from the assessment concept. Complete version available on request.

If this cannot be achieved, suitable anchor points or design enhancements (e.g. elastically insulated shear keys) must be provided.

Maximum bearing resistances for vertical and horizontal load transmission are derived using the TimberCalc online app.

STATICALLY INVESTIGATED CONNECTION DETAILS

Getzner offers the timber industry a variety of elastomer-based acoustic solutions that also meet static requirements. As part of a study⁴ carried out by Getzner in collaboration with the University of Innsbruck, the properties of Sylodyn® bearings in combination with elastic screw connections in timber construction were tested. Two different approaches are illustrated below:

1. A normal connection with 8 standard screws with no elastic bearing

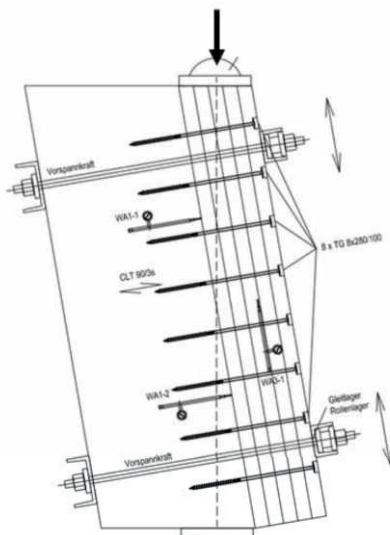

2. A connection with an elastomer strip, 8 standard screws and elastic washers

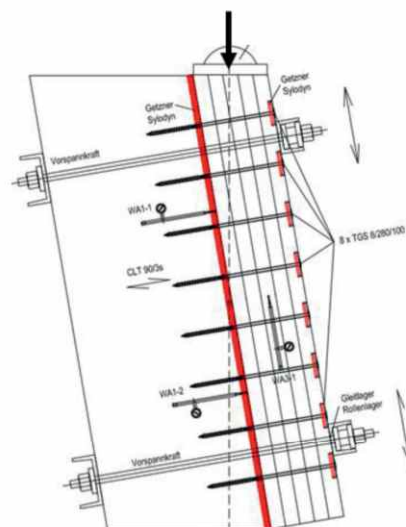

The main findings

- Elastomers are a very good way of meeting both the acoustic and static requirements.
- The test results demonstrate that the horizontal characteristic load capacity of both tested connections is more or less identical, and in any event significantly larger than the values calculated according to Eurocode5. As the superimposed load increases, the elastically mounted test scenario returns even better values than the rigid joint.
- The initial rigidity of the joint is reduced by the introduction of an elastomer.

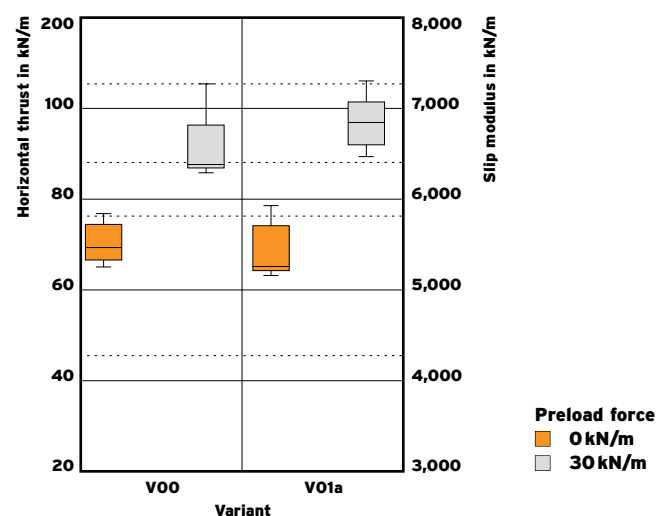

⁴ Reichelt, H., Gerhaher U., Wiederin, S., Maderebner, R., (2016), Characteristics of acoustic layers for structural design of timber constructions, Vienna

FIRE PROPERTIES OF SYLODYN®

Study⁵

- Fire resistance of wall-ceiling connections in cross laminated timber constructions
- Two connections: implemented using Sylodyn® bearings
- The fire load was exposed to a standard temperature curve for 60 minutes in a fire chamber
- The solid wood elements were screwed together with a 12.5 mm thick Sylodyn® bearing placed between the elements
- A 12.5 mm thick gypsum plaster fire protection board was applied to the party wall - the structural component; the ceiling was made of unplanked exposed timber.
- The connecting joint exposed to the fire between the wall and the ceiling was filled with two different materials, an intumescent material (Intumex AN) and a conventional acrylic paste.

Result

In both tested configurations, the temperature on the side of the joint facing away from the fire remained below 30 °C for the duration of the test. The joints therefore satisfy the fire-resistance requirements for at least 60 minutes.

Conclusion

The experiments demonstrated that Sylodyn® meets the fire-resistance requirements in the connecting joint between the wall and ceiling.



Fig. 7: Connection detail after exposure to fire for 60 minutes

⁵ Research report by Holzforschung Austria: Urbanes Bauen in Holz- und Holz-mischbauweise (Untersuchungen zum Brandverhalten von Wand- und Deckenanschlüssen), [Urban construction in timber and mixed timbers (studies of the fire properties of wall-ceiling connections)] Vienna 2008, M.Teibinger, I.Matzinger

AIRTIGHTNESS OF SYLODYN®

The flow of air through the cracks or joints in the shell of a building should be prevented for a number of reasons. A high percentage of building damage can be laid at the door of a poorly constructed building shell. In addition to excessively high heat loss, draughts cause an uncontrolled transport of moisture and add to the discomfort of the residents.

Measuring airtightness

The airtightness of a building is measured using what is known as the "blower door test". This procedure determines the air exchange rate and identifies leakages and weak points in the building shell.

The use of elastic Sylodyn® strips compensates for any slight unevenness in the joint between the ceiling and the wall, thus sealing any potentially weak spots and preventing any gaps forming.

The Sylodyn®-based elastomer bearings are made from polyurethane with a closed cellular structure, which is perfect for creating airtight connections between the wall and the ceiling. In order to meet the usual requirements in terms of wind protection, it is important to ensure that the bearings are installed correctly and without any gaps (joint to joint). This assumes that the bearing is installed according to the installation instructions.

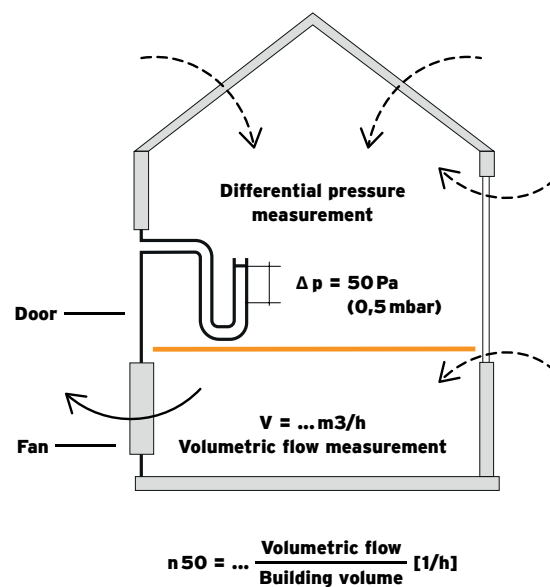

INSTALLATION INSTRUCTIONS



1
Carefully read through the instructions in the Installation Instructions before starting any work.



2
Check that the supplied materials match your installation plan. Ensure that you are aware of the exact position of the elastomers.

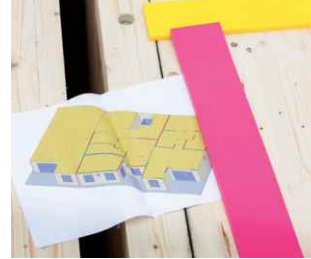
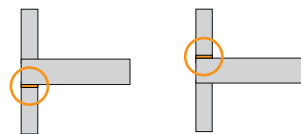

3
Prepare the substrate as set out in the construction specifications (e.g. setting threshold, base connection) and mark the positions of the bearings.



4
Refer to the construction or installation plan to cut the materials to the required length.

Any remnants can be reused, reducing waste to a minimum.



5
The bearings can now either be applied with a spray adhesive or fastened mechanically to prevent them slipping while the timber elements are positioned.

Please note:
Mechanical fastenings must lie at least 3 mm below the surface of the material.



6
Installation of bearings according to installation plan. The bearings can be butt-joined if required.

Please note:
Airtightness can only be achieved if the bearings are installed correctly.



7

Positioning the timber elements

Please note:
If the elastomers are not secured, care must be taken during positioning to ensure the bearings are not moved.



8

Frictional connections between decoupled elements must also be decoupled (e.g. GEPI angle brackets).



9

Screw connections must be pre-drilled. Elastic washers must be used to decouple the screw.

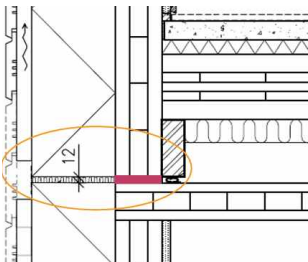

10

A complete separation or elastic decoupling of adjacent components (façade, interior purlin) is also required.

Please note:
Continuous elements can create secondary sound paths.



11

Repeat the process for all other remaining levels.

CALCULATION PROGRAM

SMOOTH AND EFFICIENT PROJECT PLANNING WITH TIMBERCALC.



Simple



Clear



Quick

TimberCalc allows you to select the Sylodyn® strips for your sound control solution quickly and easily.

- 1 Based on the structural conditions and any already defined ceiling and wall structures, the necessary bearing positions can be ascertained with the help of the construction rules on page 18.
- 2 Various components that make up the ceilings and partitions can be found on pages 32-37. Together with the Kij values (page 19), these can be used for the EN 12354 calculation (page 7) to determine the expected level of sound control.
- 3 The appropriate Sylodyn® bearings for the loads in question are selected using the TimberCalc calculation program. TimberCalc is available free of charge from <http://apps.getzner.com>.
- 4 All the data necessary for determining the ideal Sylodyn® bearing is entered from the input screen
 - Item number
 - Length, width and thickness of the bearing
 - Type of bearing (point / strip)
 - Characteristic dead weight
 - Characteristic working load
- 5 The program determines which type of Sylodyn® is best and displays all the relevant material data at a glance
 - Existing bearing pressure
 - Optimum material
 - Deflection (after 1 day and 10 years)
 - Natural frequency
 - Capacity of material
- 6 The table produced by the program can be downloaded in PDF format. The data can also easily be imported into other programs, e.g. Excel, for further processing.
- 7 It will then be available at every workstation for the straightforward creation of a parts list and an installation plan based on existing plans.
- 8 The Sylodyn® bearings are installed in accordance with this parts list and the installation plan created by Getzner Werkstoffe at the request of the customer (charged at cost). This will ensure a problem-free installation. It is also possible for a Getzner employee to oversee the installation on site.



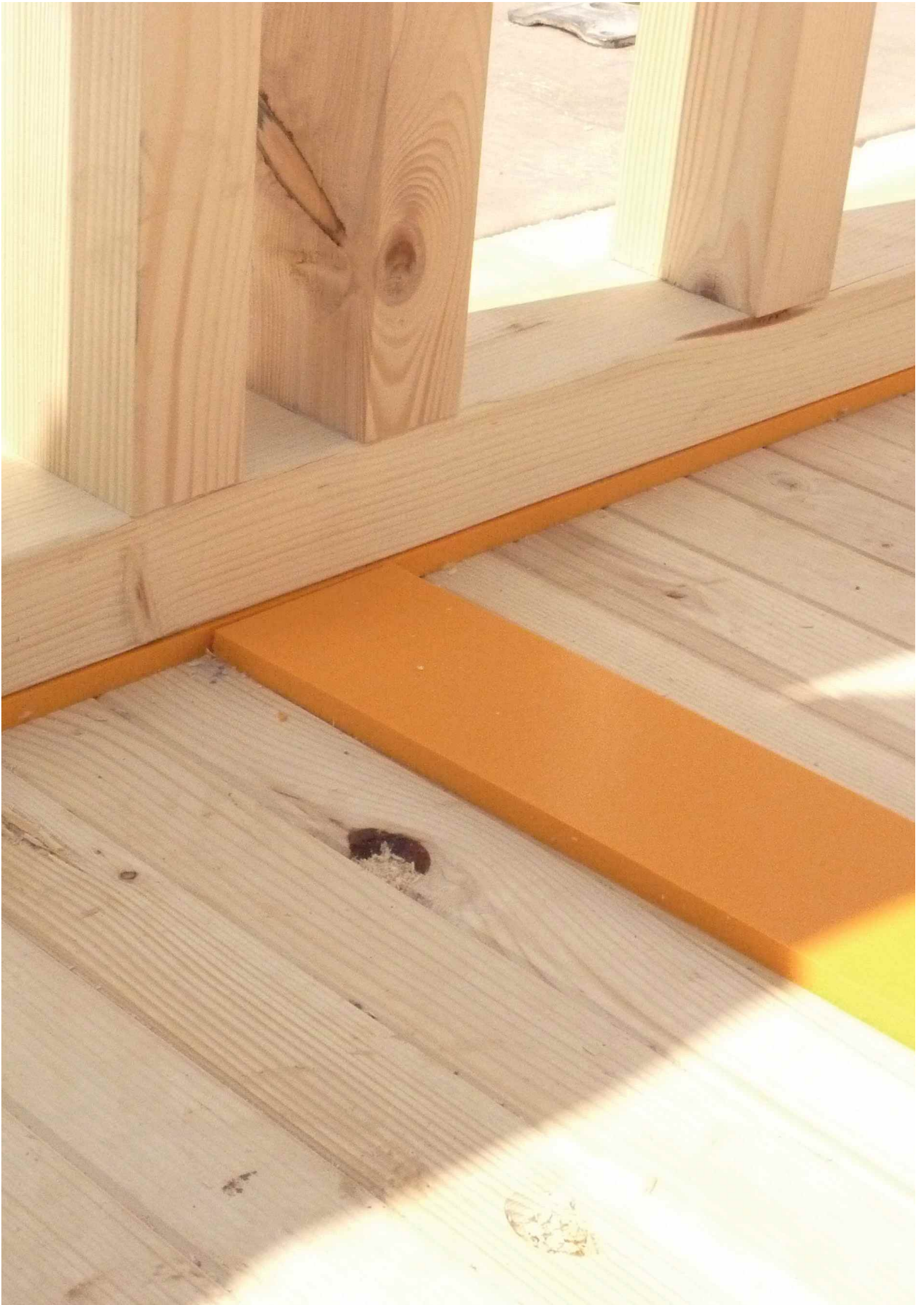

DETAILED DRAWINGS

Getzner provides appropriate solutions to a variety of challenges and can draw on years of experience. We develop bespoke design drawings in collaboration with our customers, taking the respective project-specific requirements into account.

Sound control ex works

To further enhance the level of prefabrication, Getzner offers the option of applying the bearings directly to the corresponding elements in the factory. Two approaches have proved themselves over the years: Bonding the bearings to the elements using spray adhesive and the use of Sylodyn® secured with double-sided adhesive tape.

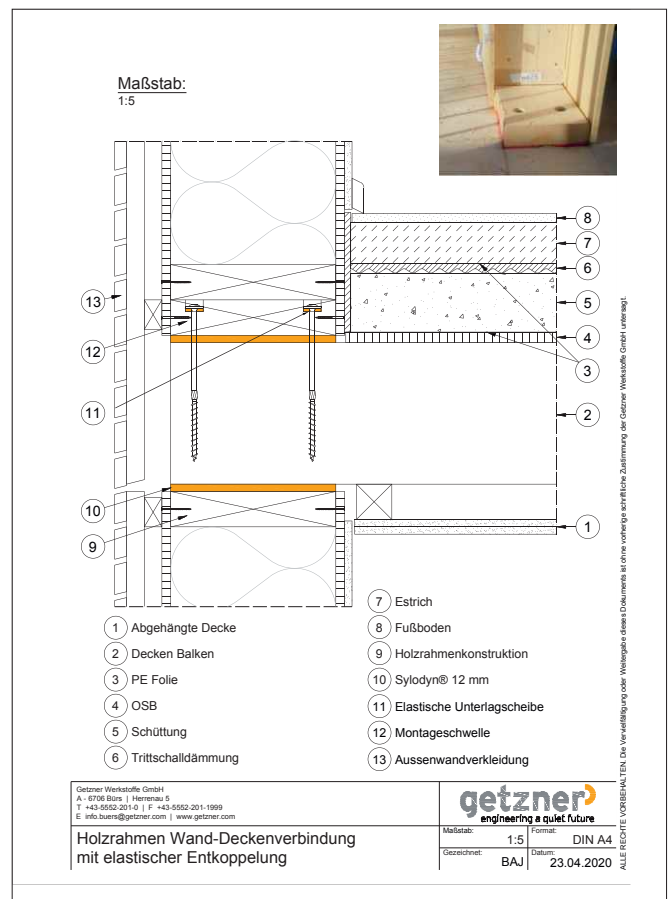

CEILING CONSTRUCTIONS

Box element with dry screed

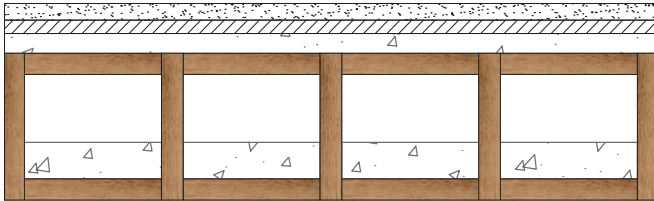

25 mm	Dry screed 28.7 kg/m ²
20 mm	Wood fibre s' ≤ 30 MN/m ³
30 mm	Honeycomb filling 45 kg/m ²
200 mm	Surface element 39 kg/m ² with stone chippings 90 kg/m ²

Airborne noise



Impact noise

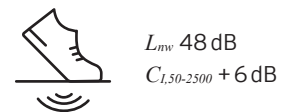

Box element with cement screed

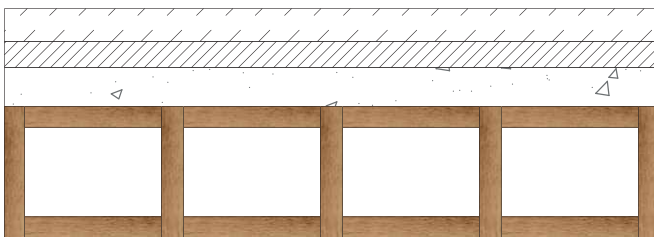

50 mm	Cement screed 110 kg/m ²
40 mm	Mineral fibre insulation s' < 7 MN/m ³
60 mm	Stone chippings 84 kg/m ²
200 mm	Panel element 39 kg/m ²

Airborne noise

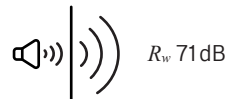

Impact noise

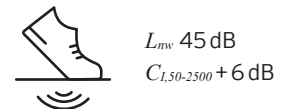

Box element with false floor

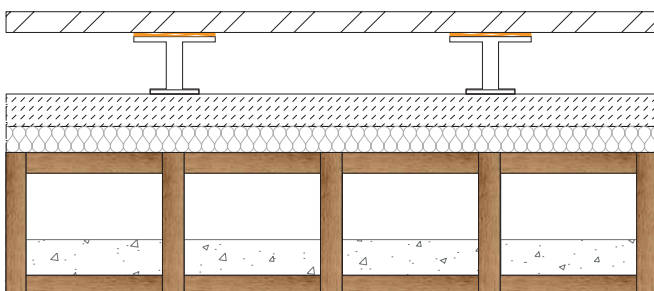

32 mm	False floor deck 52 kg/m ²
100 mm	Support with Sylodyn® false floor pad
50 mm	Cement screed
40 mm	Mineral fibre insulation s' ≤ 7 MN/m ³
200 mm	Panel element 39 kg/m ² with stone chippings 50 kg/m ²

Airborne noise

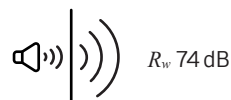

Impact noise

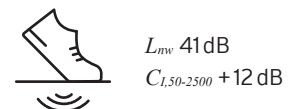

Timber ceiling with concrete slab filling

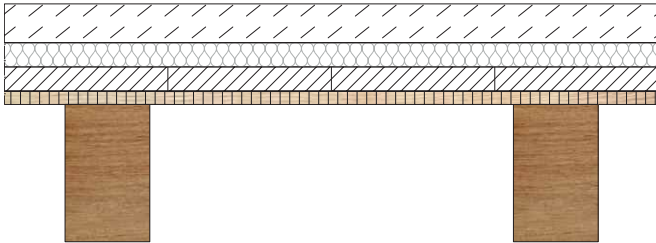

50 mm	Cement screed 28.7 kg/m ²
40 mm	Mineral fibre insulation $s' \leq 30 \text{ MN/m}^3$
40 mm	Concrete slabs 45 kg/m ²
22 mm	Surface element 39 kg/m ² with stone chippings 90 kg/m ²
280 mm	Beam ceiling 30.7 kg/m ²

Airborne noise



R_w 72 dB

Impact noise



L_{nw} 47 dB
 $C_{1,50-2500} + 4 \text{ dB}$

Timber ceiling with stone chippings

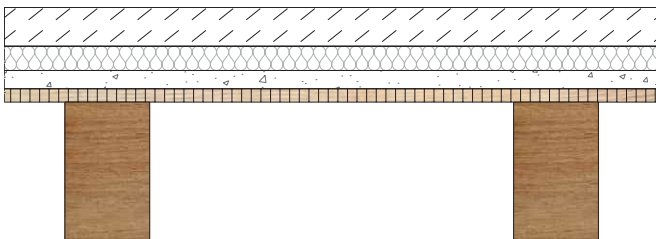

50 mm	Cement screed 120 kg/m ²
40 mm	Mineral fibre insulation $s' \leq 6 \text{ MN/m}^3$
30 mm	Chippings 45 kg/m ²
22 mm	Planking 15 kg/m ²
280 mm	Beam ceiling 30.7 kg/m ²

Airborne noise



R_w 67 dB

Impact noise



L_{nw} 50 dB
 $C_{1,50-2500} + 4 \text{ dB}$

Timber ceiling with suspended substructure and dry screed

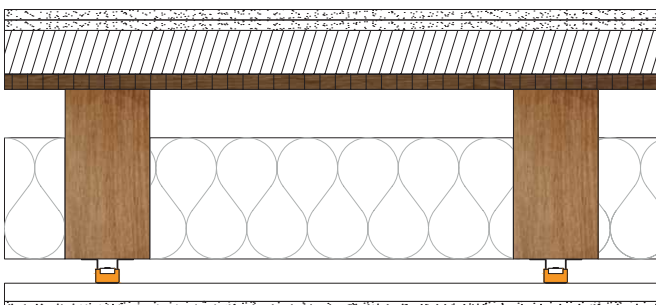

2 × 10 mm	Dry screed 36.5 kg/m ²
65 mm	Pressure-resistant mineral fibre insulation $s' \leq 50 \text{ MN/m}^2$
25 mm	Solid wood panel 11.8 kg/m ²
220 mm	Beam ceiling with void damping, Akustik + Sylomer® ceiling hangers
50 mm	Suspended substructure 1.8 kg/m ²
15 mm	Ceiling lining 16 kg/m ²

Airborne noise

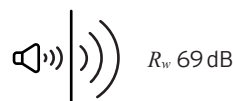

R_w 69 dB

Impact noise



L_{nw} 50 dB
 $C_{1,50-2500} + 6 \text{ dB}$

Timber ceiling with suspended substructure, dry screed and ceiling filling

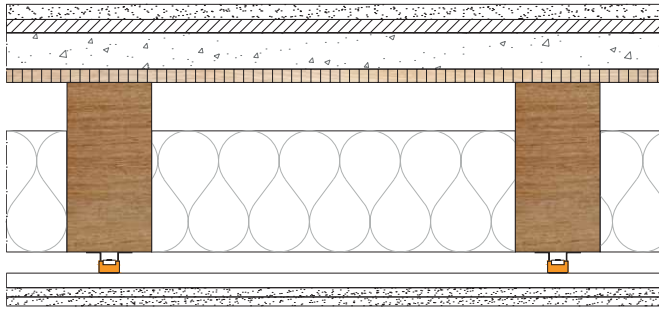

25 mm	Dry screed 26.7 kg/m ²
22 mm	Wood fibre s' ≤ 30 MN/m ³
60 mm	Stone chippings 90 kg/m ²
25 mm	Planking 11.8 kg/m ²
280 mm	Joist support structure with void damping 30.7 kg/m ²
50 mm	Akustik + Sylomer® ceiling hangers with substructure 1.8 kg/m ²
2 × 15 mm	Double-layer ceiling lining 32 kg/m ²

Airborne noise



Impact noise

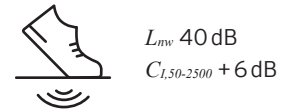

Timber ceiling with suspended substructure and cement screed

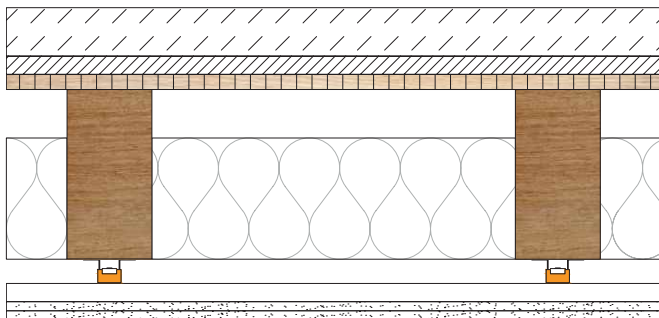

55 mm	Cement screed 110 kg/m ²
30 mm	Mineral fibre insulation s' ≤ 6 MN/m ³
25 mm	Planking 11.8 kg/m ²
280 mm	Beam ceiling with void damping 30.7 kg/m ²
50 mm	Akustik + Sylomer® ceiling hangers with substructure 1.8 kg/m ²
2 × 15 mm	Double-layer ceiling lining 22 kg/m ²

Airborne noise

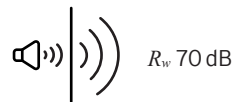

Impact noise

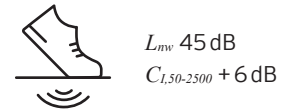

Timber ceiling with Sylomer® and insertion boards

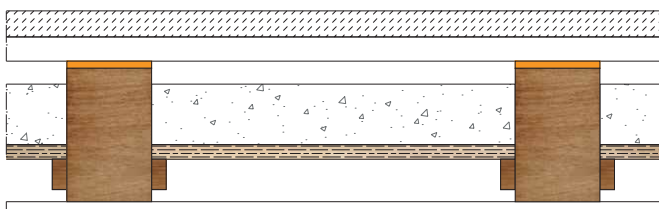

53 mm	Cement screed on trapezoidal profile 176 kg/m ²
12 mm	Sylomer® bearing
220 mm	Beam ceiling with insertion board and filling 120 kg/m ²
18 mm	Ceiling lining 26 kg/m ²

Airborne noise



Impact noise

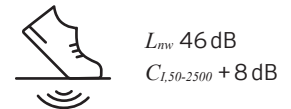

Timber beam ceiling with Sylomer® and suspended substructure

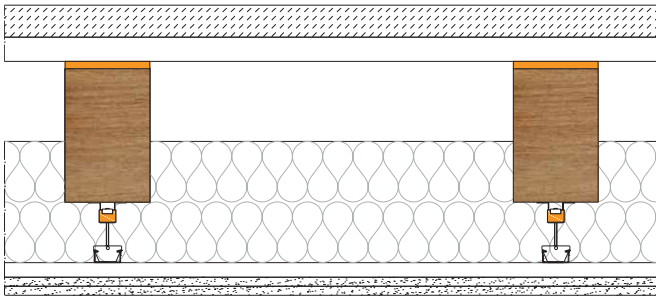

53 mm	Cement screed on trapezoidal profile 176 kg/m ²
12,5 mm	Sylomer® bearing
220 mm	Joist support structure with void damping 120 kg/m ²
20 mm	Akustik + Sylomer® ceiling hangers with substructure 1.8 kg/m ²
25 mm	Double-layer ceiling lining 26.7 kg/m ²

Airborne noise

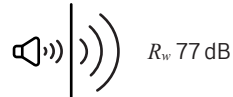

Impact noise

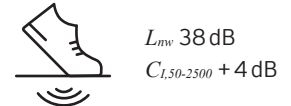

Cross laminated timber ceiling with cement screed

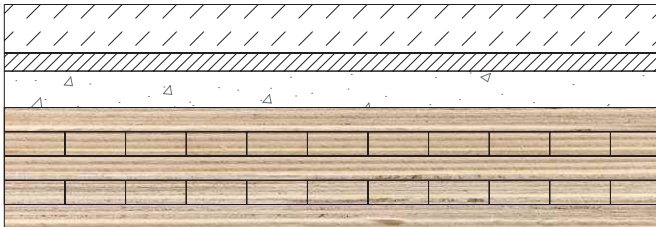

80 mm	Cement screed 176 kg/m ²
30 mm	Mineral wool $s' \leq 6$ MN/m ³
60 mm	Stone chippings 84 kg/m ²
200 mm	Cross laminated timber ceiling (CLT) 94 kg/m ²

Airborne noise

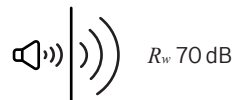

Impact noise

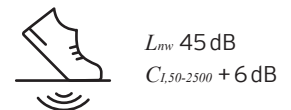

Cross laminated timber ceiling with dry screed and suspended substructure

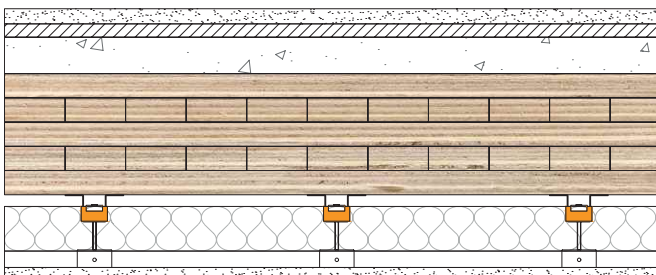

25 mm	Dry screed 26.7 kg/m ²
22 mm	Wood fibre $s' \leq 30$ MN/m ³
60 mm	Stone chippings 84 kg/m ²
200 mm	Cross laminated timber ceiling (CLT) 94 kg/m ²
120 mm	Akustik + Sylomer® ceiling hangers with substructure and void damping 1.8 kg/m ²
15 mm	Ceiling lining 16 kg/m ²

Airborne noise

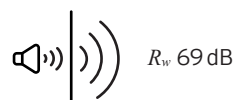

Impact noise

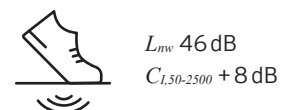

Cross laminated timber ceiling with cement screed and suspended substructure

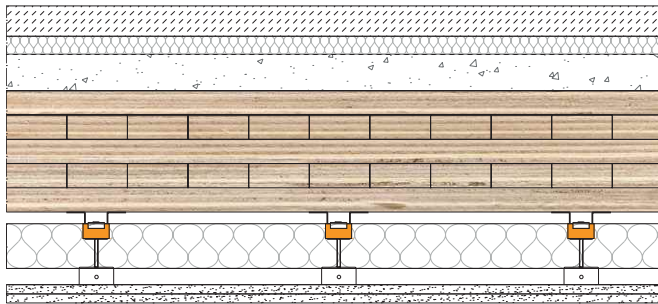

50 mm	Cement screed 105 kg/m ²
30 mm	Mineral wool s' ≤ 8 MN/m ³
65 mm	Stone chippings 90 kg/m ²
200 mm	Cross laminated timber ceiling (CLT) 94 kg/m ²
100 mm	Akustik + Sylomer® ceiling hangers with substructure and void damping 1.8 kg/m
2 × 12,5 mm	Double-layer ceiling lining 26.7 kg/m ²

Airborne noise

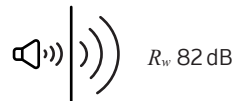

R_w 82 dB

Impact noise



L_{nw} 23 dB
 $C_{1,50-2500}$ + 26 dB

Cross laminated timber ceiling with cement screed and rigid substructure

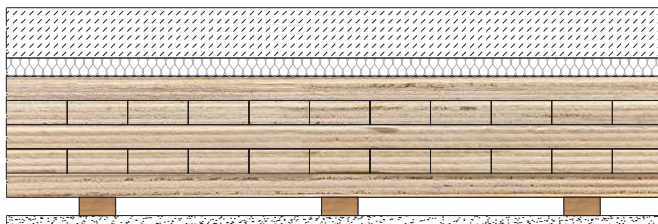

80 mm	Cement screed 176 kg/m ²
30 mm	Mineral wool s' ≤ 6 MN/m ³
200 mm	Cross laminated timber ceiling (CLT) (CLT) 94 kg/m ²
40 mm	Counterbattening 2 kg/m ²
15 mm	Ceiling lining 16 kg/m ²

Airborne noise

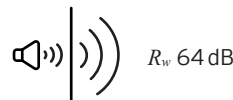

R_w 64 dB

Impact noise



L_{nw} 51 dB
 $C_{1,50-2500}$ + 5 dB

Cross laminated timber ceiling with terrace grating

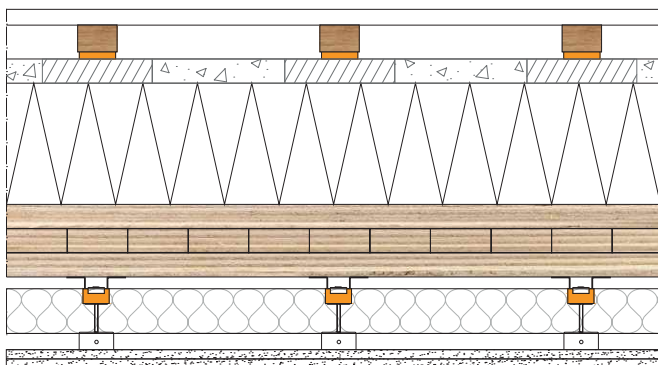

26 mm	Wooden floorboards 10 kg/m ²
44 mm	Squared timber
12 mm	Sylomer® terrace pad
40 mm	Concrete slabs and stone chippings 90 kg/m ²
200 mm	EPS isolation 2.5 kg/m ²
140 mm	Cross laminated timber ceiling (CLT) 94 kg/m ²
90 mm	Akustik + Sylomer® ceiling hangers with substructure and void damping 1.8 kg/m
2 × 12,5 mm	Double-layer ceiling lining 26.7 kg/m ²

Airborne noise

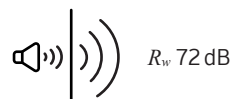

R_w 72 dB

Impact noise



L_{nw} 45 dB
 $C_{1,50-2500}$ + 4 dB

Timber-concrete hybrid ceiling with cement screed

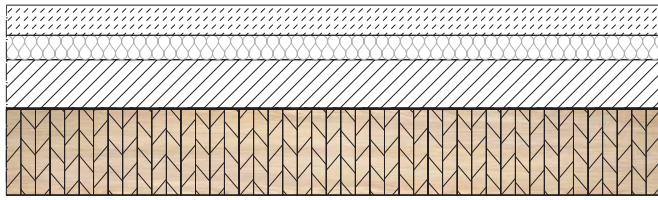

50 mm	Cement screed 120 kg/m ²
40 mm	Mineral wool $s' \leq 7 \text{ MN/m}^3$
80 mm	Top concrete layer 200 kg/m ²
120 mm	Laminated timber ceiling 54 kg/m ²

Airborne noise

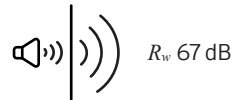

Impact noise

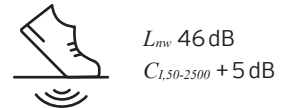

Timber-concrete hybrid ceiling with false floor

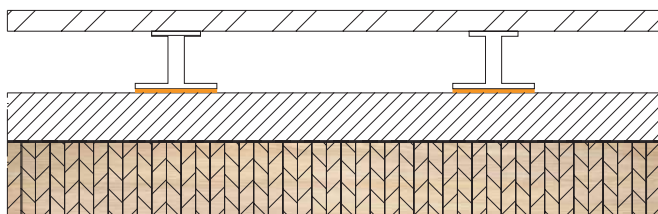

70 mm	False floor deck 96 kg/m ²
180 mm	Support on Sylodyn® false floor pad
120 mm	Top concrete layer 288 kg/m ²
100 mm	Laminated timber ceiling 45 kg/m ²

Airborne noise

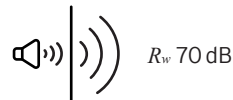

Impact noise

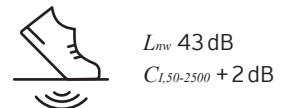

LVL ceiling with suspended substructure

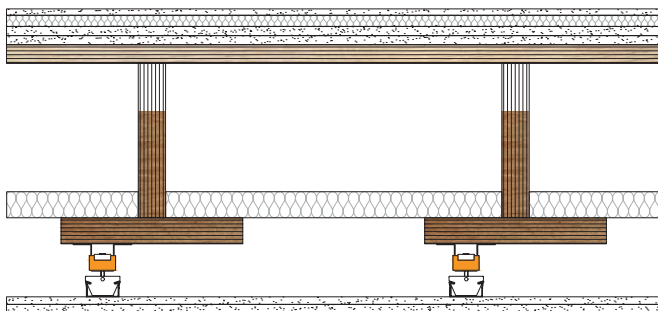

17 mm	Floor covering with impact noise insulation
18 mm	Drywall panel 20 kg/m ²
2 × 15 mm	Drywall panels 22 kg/m ²
31 mm	LVL panel
303 mm	LVL beam support structure with void damping
93 mm	Akustik + Sylomer® ceiling hangers with substructure 1.8 kg/m ²
2 × 15 mm	Drywall panels 22 kg/m ²

Airborne noise

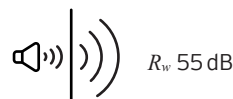

Impact noise

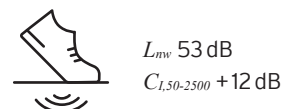

The listed values are partly out of databases and can be even better in reality.

Sources: Schallschutz im Holzbau, Holzbauhandbuch [Sound control in timber construction, Timber construction handbook], Informationsdienst Holz

Schalltechnische Sanierung, Holzbalkendecken gezielt auf Vordermann bringen [Acoustic renovation, knocking timber beam ceilings into shape], Mikado plus 3/2008 Deckenkonstruktionen für den mehrgeschossigen Holzbau, Schall- und Brandschutz [Ceiling structures for multi-storey timber buildings, Sound control and fire prevention], Holzforschung Austria lignumdata.ch; dataholz.eu; opensourcewood.com; lignatur.ch; rigips.at

EXAMPLE CALCULATION FOR A SOLID TIMBER CONSTRUCTION

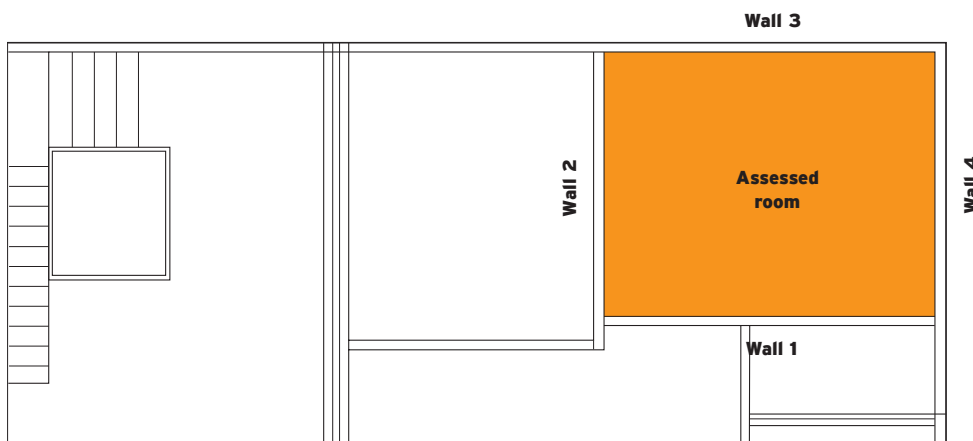

Acoustic certification according to EN 12354-1 and EN 12354-2

To demonstrate the effect of flanking noise insulation, an example calculation for a solid timber construction was performed on the basis of the simplified calculation method according to EN 12354 using the flanking sound reduction index computed in the laboratory (see page 19).

The scenario envisaged two rooms located on top of each other in the corner of a multi-storey dwelling built of solid timber. The room dimensions are 4×3 m. The building façade was ignored with regard to flanking transmission from the upper to the lower room.

Separating component (ceiling):

55 mm floating screed, 110 kg/m²
30 mm impact noise insulation, 6 MN/m²
60 mm chippings, 84 kg/m²
200 mm solid timber ceiling, 94 kg/m²

($L_{mv} = 48$ dB | $R_w = 67$ dB)

With elastically suspended ceiling as option, 32 kg/m²

($L_{mv} = 33$ dB | $R_w = 80$ dB)

Flanking components (external walls):

Planked on the inside with 80 mm solid timber, 47 kg/m²
The facade on the outside was ignored

($R_w = 35$ dB)

Flanking components (internal walls):

Planked on both sides with 80 mm solid timber, 69 kg/m²

($R_w = 37$ dB)

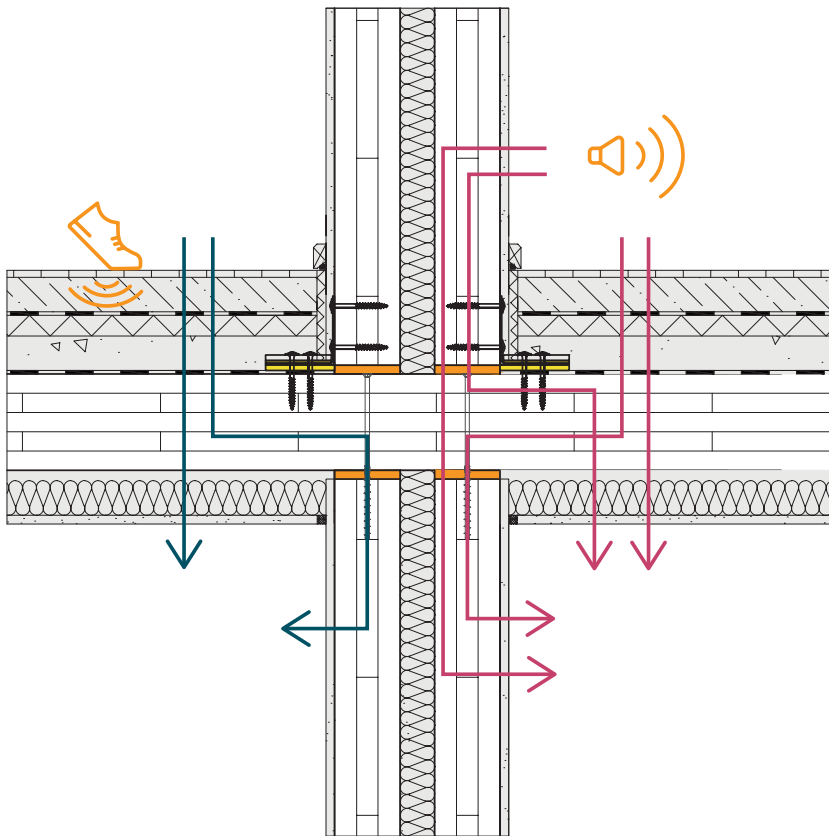

Fig. 8: Tritt- und Luftschallübertragungswege am Beispiel der Wohnungstrennwand

As an additional sound control solution, elastic flank decoupling was initially installed on top of the ceiling. In a subsequent step, it was also placed underneath the ceiling and a suspended ceiling installed.

The classification defined in DEGA recommendation 103-1 was used for the qualitative assessment (see page 4). In practice, this assessment should be made according to the respective project-specific requirements and/or national regulations.

In the following calculation, the individual transmission paths for all existing internal and external walls, together with the direct transmission, were computed and cumulated.

In other words, the calculated impact noise level - shown in blue in Fig. 8 - is derived from the total of the four flanking transmission paths (all four wall elements), plus the direct transmission through the actual partitioning element.

In order to arrive at a computed result for airborne noise transmission - shown in red - a total of twelve transmission paths via the flanks (all four wall elements, each with three potential transmission paths) have to be considered in addition to the direct sound transmission.

The formulae on page 7 and the corresponding project details were used for this purpose. See page 42 for the results in diagrammatic form.

SIMPLIFIED PROCEDURE AS PER EN 12354-1 AND EN 12354-2: INCREASED SOUND CONTROL

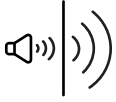

Airborne noise

One transmission path was calculated for example purposes and added to the results of the other transmission paths.

The rated sound reduction index for the 'ceiling-wall 1' transmission path is calculated as follows:

$$R_{D1,w} = \frac{48.0 \text{ dB} + 37.0 \text{ dB}}{2} + 19.0 \text{ dB} + 25.5 \text{ dB} + 10 \log \frac{12.0 \text{ m}^2}{1.0 \text{ m} \cdot 4.0 \text{ m}} = 91.8 \text{ dB}$$

The results for all 'ceiling-wall' transmission paths are as follows:

$$R_{D1,w} = 91.8 \text{ dB}$$

$$R_{D2,w} = 93.0 \text{ dB}$$

$$R_{D3,w} = 89.8 \text{ dB}$$

$$R_{D4,w} = 91.0 \text{ dB}$$

The cumulated rated sound reduction index for the 'ceiling-wall' transmission path is calculated as follows:

$$\text{Sum } R_{Df,w} = -10 \log \left(\sum 10^{\frac{-R_{Df,w}}{10}} = -10 \log \left(10^{\frac{-91.8 \text{ dB}}{10}} + 10^{\frac{-93.0 \text{ dB}}{10}} + 10^{\frac{-89.8 \text{ dB}}{10}} + 10^{\frac{-91.0 \text{ dB}}{10}} \right) = 85.2 \text{ dB} \right)$$

The results for all cumulated 'ceiling-wall', 'wall-ceiling', 'wall-wall', and 'ceiling-ceiling' transmission paths are as follows:

$$R_{Dd,w} = 80.0 \text{ dB}$$

$$\text{Sum } R_{Df,w} = 85.2 \text{ dB}$$

$$\text{Sum } R_{Fd,w} = 88.7 \text{ dB}$$

$$\text{Sum } R_{Ff,w} = 71.4 \text{ dB}$$

The cumulated rated sound reduction index for the 'ceiling-wall' transmission path is calculated as follows:

$$R'_w = -10 \log \left(10^{\frac{-80.0 \text{ dB}}{10}} + 10^{\frac{-85.2 \text{ dB}}{10}} + 10^{\frac{-88.7 \text{ dB}}{10}} + 10^{\frac{-71.4 \text{ dB}}{10}} \right) \approx 71 \text{ dB}$$



Impact noise

One transmission path was calculated for example purposes and added to the results of the other transmission paths.

The rated normalised impact noise level for the 'ceiling-wall 1' transmission path is calculated as follows:

$$L_{n,D1,w} = 74.0 \text{ dB} - 26.0 \text{ dB} + \frac{48.0 \text{ dB} - 37.0 \text{ dB}}{2} - 0.0 \text{ dB} - 25.5 \text{ dB} - 10 \log \frac{12.0 \text{ m}^2}{1.0 \text{ m} \cdot 4.0 \text{ m}} = 23.2 \text{ dB}$$

The results for all 'ceiling-wall' transmission paths are as follows:

$$L_{n,D1,w} = 23.2 \text{ dB}$$

$$L_{n,D2,w} = 22.0 \text{ dB}$$

$$L_{n,D1,w} = 25.2 \text{ dB}$$

$$L_{n,D1,w} = 24.0 \text{ dB}$$

The cumulated normalized impact sound pressure level for the 'ceiling-wall' transmission path is calculated as follows:

$$\text{Sum } L_{n,Df,w} = 10 \log \left(\sum 10^{\frac{L_{n,Df,w}}{10}} \right) = 10 \log \left(10^{\frac{23.2 \text{ dB}}{10}} + 10^{\frac{22.0 \text{ dB}}{10}} + 10^{\frac{25.2 \text{ dB}}{10}} + 10^{\frac{24.0 \text{ dB}}{10}} \right) = 29.8 \text{ dB}$$

The results for all cumulated 'ceiling-wall', 'wall-ceiling', 'wall-wall', and 'ceiling-ceiling' transmission paths are as follows:

$$L_{n,Dd,w} = 33.0 \text{ dB}$$

$$\text{Sum } L_{n,Df,w} = 29.8 \text{ dB}$$

The overall normalized impact sound pressure level is thus derived by adding together all transmission paths as follows:

$$R'_{n,w} = 10 \log \left(10^{\frac{33.0 \text{ dB}}{10}} + 10^{\frac{29.8 \text{ dB}}{10}} \right) \text{ dB} \approx 35 \text{ dB}$$

EXAMPLE CALCULATION

Low sound control

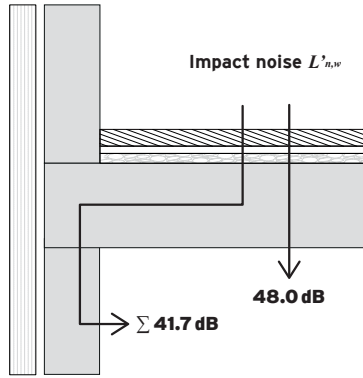
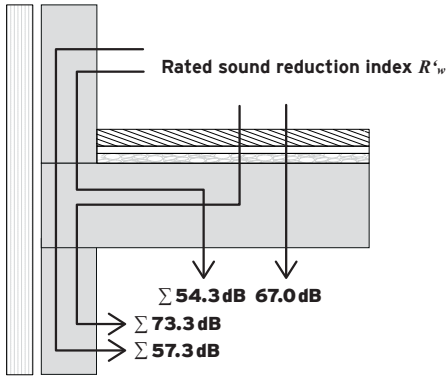

Result without flank decoupling and no suspended ceiling:

$R'_{w} = 52 \text{ dB}$	Class E
$L'_{n,w} = 49 \text{ dB}$	Class D

Requirements for the legal minimum level of sound control generally not satisfied. Disturbance caused by sound transmission from the room above is to be expected.

Average sound control

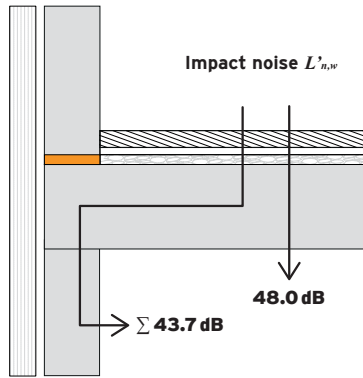
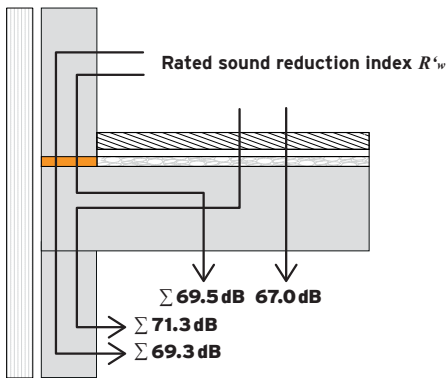

With flank decoupling above, no suspended ceiling:

$R'_{w} = 63 \text{ dB}$	Class B
$L'_{n,w} = 49 \text{ dB}$	Class D

Requirements for the legal minimum level of sound control generally satisfied. Noise from the room above will still be audible every now and then.

Increased sound control

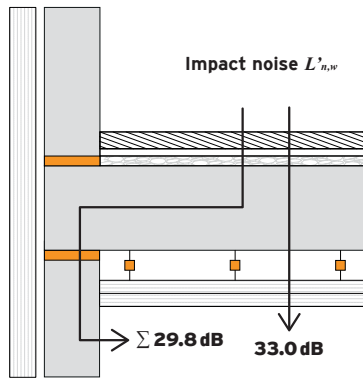
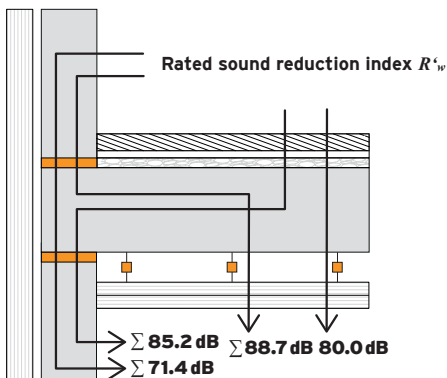

With flank decoupling above and below, with suspended ceiling:

$R'_{w} = 71 \text{ dB}$	Klasse A
$L'_{n,w} = 35 \text{ dB}$	Klasse A

Increased level of sound control provided. Everyday noises from the room above do not disturb or can usually no longer be heard.

CONCLUSION

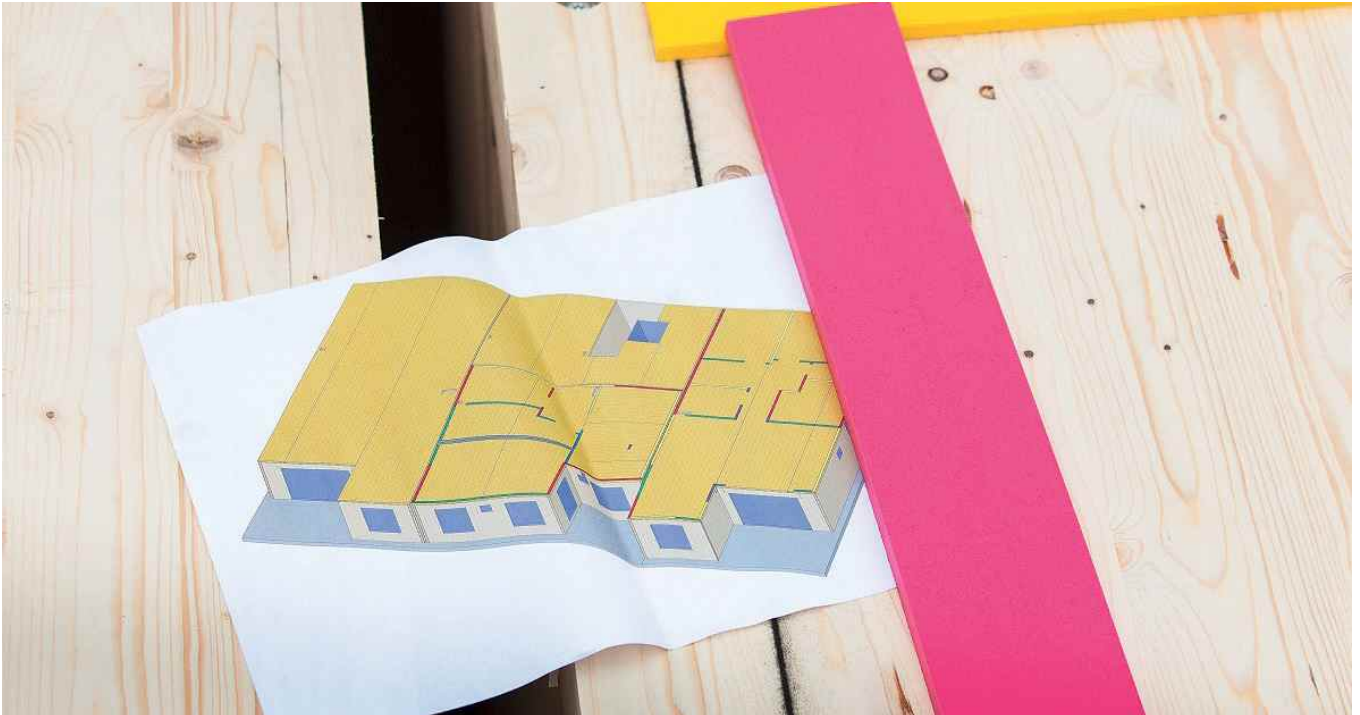

More stringent sound control requirements in timber construction have led to the development of high-quality wall and ceiling structures. The higher the level of the partitioning elements, the greater the importance of efficient acoustic decoupling of the flanking elements, as we were able to demonstrate in an example calculation.

The method adopted to calculate the level of required noise insulation, including the flanking elements, is described in EN 12354.

The vibration reduction index K_{ij} specified in the standard defines the effectiveness of the flank decoupling. A series of comprehensive measurements using Sylodyn® insulating strips was carried out, from which K_{ij} values for all existing transmission situations could be derived.

The K_{ij} values to be applied should take account of the effect of the fasteners used. Investigations into the effect of the fastening showed hardly any reduction in effectiveness when carefully installed, elastically decoupled screws were used. In the case of rigid fasteners, by contrast, a reduction of 35% was measured; even the use of an occasional rigid screw produces discernible sound bridges and consequently has an adverse effect on vibration reduction.



Getzner Werkstoffe, Bürs

ENGINEERING A QUIET FUTURE

Getzner Werkstoffe is a leading global expert in vibration isolation for the railway, construction and industrial sectors. Our advanced elastic solutions are designed to minimise vibration and noise, helping to safeguard structures, enhance system efficiency and improve comfort.

Our materials are engineered in-house and set new benchmarks for performance, durability and sustainability. That includes foamed polyurethanes like Sylomer® and Sylodyn®, spring elements from the Isotop® family, as well as innovative recycled elastomers such as Relomer®. They form the backbone of our proven applications and integrated solutions - from analysis and design through to installation.

With more than fifty years of pioneering work and market experience, we combine deep system expertise with a firm commitment to innovation and climate-friendly production. Since our founding in 1969 in Bürs, Austria, we have grown into a globally established company, operating our own locations on five continents.

[getzner.com](https://www.getzner.com)

Getzner Werkstoffe GmbH

Herrenau 5
6706 Bürs, Austria
T +43-5552-201-0
info.buers@getzner.com