

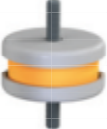

Isotop Compact

Vibration damper for low installation heights,
with diverse attachment options

- Natural frequency from 9.9Hz
- Very low overall height of 28 mm (T/T version)
- Load capacity of up to 95 kg per element
- 25 mm Sylomer® or Sylodyn® inside
- High level of corrosion protection
- Secure connection between the plate and the polyurethane damper thanks to special adhesive
- M8 internal thread and/or M8 stud bolts for easy screw-fixing
- Available in four different attachment options
- Can also be used as an anti-slip machine mounting (B/- version)

		Maximum load		Natural frequency at maximum load	Packaging unit	Order number
		in kg	in N			
Compact T/T 	Isotop Compact-4 T/T	4	41	12.1Hz	50 pcs.	39504
	Isotop Compact-9 T/T	8	79	11.6Hz	50 pcs.	39505
	Isotop Compact-15 T/T	15	147	11.5 Hz	50 pcs.	39506
	Isotop Compact-20 T/T	27	264	10.7 Hz	50 pcs.	39507
	Isotop Compact-40 T/T	37	363	10.0 Hz	50 pcs.	38884
	Isotop Compact-50 T/T	50	491	10.9 Hz	50 pcs.	39508
	Isotop Compact-70 T/T	63	619	9.9 Hz	50 pcs.	39509
	Isotop Compact-100 T/T	95	931	10.5 Hz	50 pcs.	39511
Compact B/B 	Isotop Compact-4 B/B	4	41	12.1Hz	50 pcs.	39521
	Isotop Compact-9 B/B	8	79	11.6Hz	50 pcs.	39522
	Isotop Compact-15 B/B	15	147	11.5 Hz	50 pcs.	39523
	Isotop Compact-20 B/B	27	264	10.7 Hz	50 pcs.	39524
	Isotop Compact-40 B/B	37	363	10.0 Hz	50 pcs.	39525
	Isotop Compact-50 B/B	50	491	10.9 Hz	50 pcs.	39526
	Isotop Compact-70 B/B	63	619	9.9 Hz	50 pcs.	39527
	Isotop Compact-100 B/B	95	931	10.5 Hz	50 pcs.	39529
Compact B/T 	Isotop Compact-4 B/T	4	41	12.1Hz	50 pcs.	39512
	Isotop Compact-9 B/T	8	79	11.6Hz	50 pcs.	39513
	Isotop Compact-15 B/T	15	147	11.5 Hz	50 pcs.	39514
	Isotop Compact-20 B/T	27	264	10.7 Hz	50 pcs.	39515
	Isotop Compact-40 B/T	37	363	10.0 Hz	50 pcs.	39516
	Isotop Compact-50 B/T	50	491	10.9 Hz	50 pcs.	39517
	Isotop Compact-70 B/T	63	619	9.9 Hz	50 pcs.	39518
	Isotop Compact-100 B/T	95	931	10.5 Hz	50 pcs.	39520
Compact B/- 	Isotop Compact-4 B/-	4	41	12.1Hz	50 pcs.	41135
	Isotop Compact-9 B/-	8	79	11.6Hz	50 pcs.	41136
	Isotop Compact-15 B/-	15	147	11.5 Hz	50 pcs.	41137
	Isotop Compact-20 B/-	27	264	10.7 Hz	50 pcs.	41138
	Isotop Compact-40 B/-	37	363	10.0 Hz	50 pcs.	41139
	Isotop Compact-50 B/-	50	491	10.9 Hz	50 pcs.	41140
	Isotop Compact-70 B/-	63	619	9.9 Hz	50 pcs.	41141
	Isotop Compact-100 B/-	95	931	10.5 Hz	50 pcs.	41143

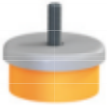
Compact -70 and -100: Not held in stock. Delivery time on request.

Isotop Compact T/T (unloaded)

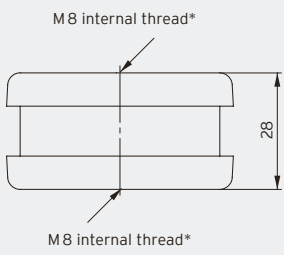

Isotop Compact B/T (unloaded)

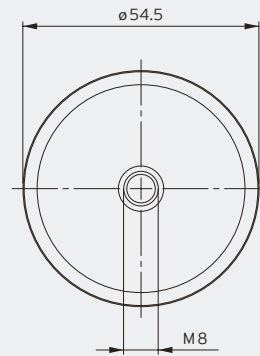
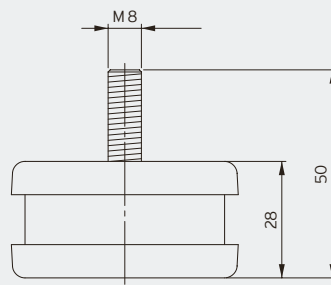

* Thread reach for internal thread max. 7 mm

Isotop Compact B/B (unloaded)

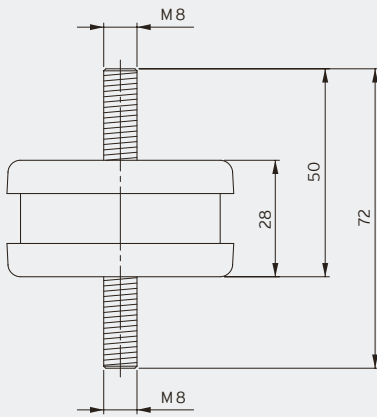

Isotop Compact B/- (unloaded)

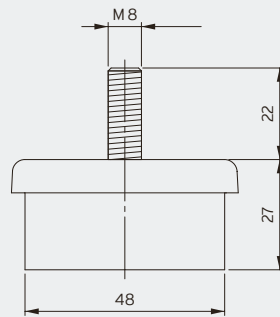

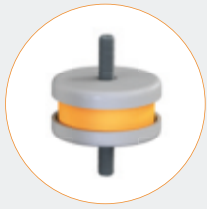

Isotop Compact

Isotop Compact 4

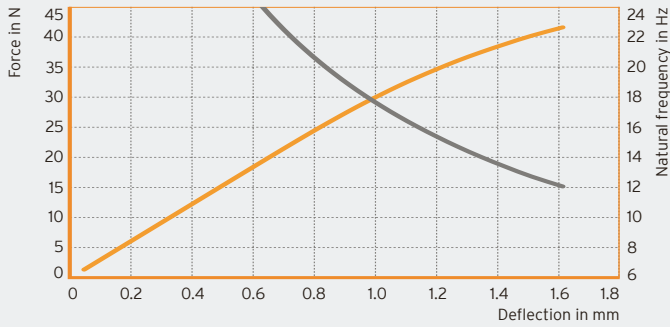

Isotop Compact 9

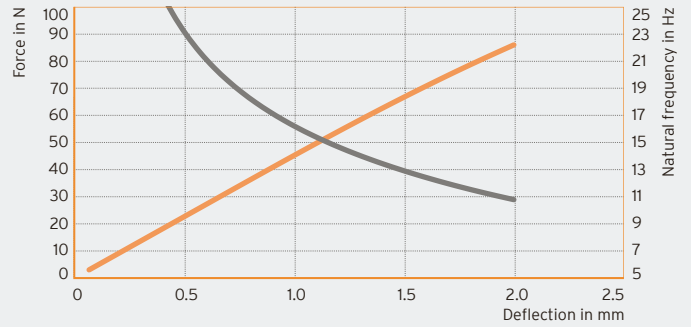

Isotop Compact 15

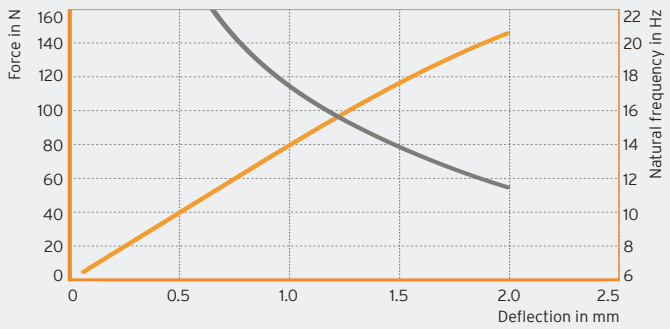

Isotop Compact 20

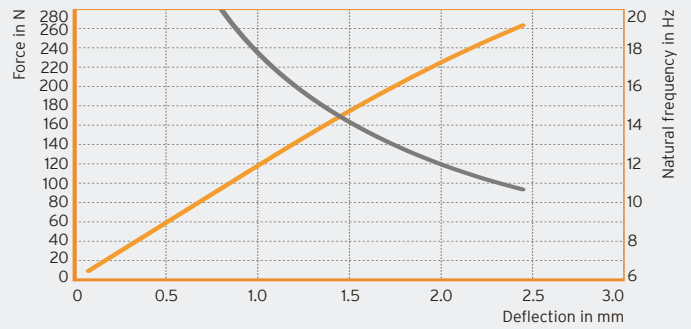

Isotop Compact 40

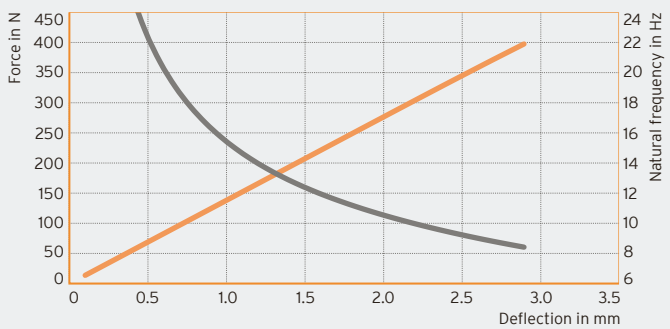

Isotop Compact 50

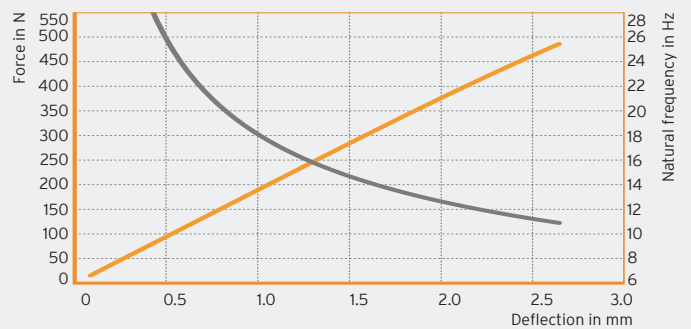

Isotop Compact 70

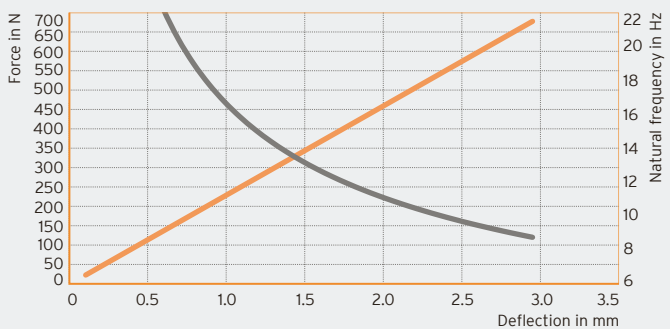

Isotop Compact 100

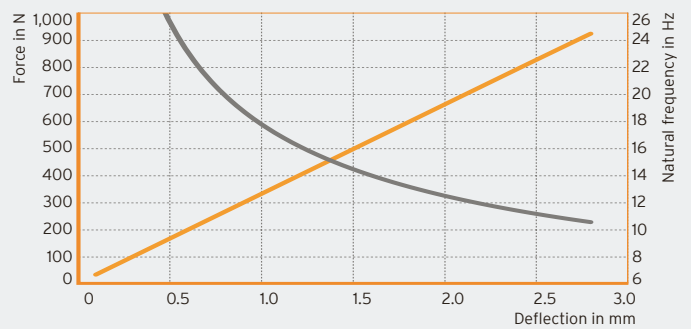

— Force in N
— Natural frequency in Hz



Small air compressor on Isotop Compact B/-



Heat pump bearing with Isotop Compact



External air conditioning unit on wall bracket



Bearing of a reciprocating compressor with Isotop Compact

DB Isotop en © Copyright by Getzner Werkstoffe GmbH | 06-2022 | All information and data is based on our current knowledge. It can be used for calculations and for reference purposes, but is subject to product-specific and application-specific manufacturing tolerances and does not represent warranted properties. Material properties and their tolerances vary depending on the type of application and load and are available from Getzner on request. Subject to change without notice. For further general information, see VDI directive 2062 and glossary. Further characteristic values available on request.